

**Silo filling device
with pinch valve**

SFA-Q

Operating instructions

Index	Page
Safety instructions	02
Operating instructions	
1. Specification	03
1.1 Extent of delivery	
1.2 Intended use	
1.3 Function	
1.4 Technical data	
1.5 Materials	
2. Installation	03
2.1 Preparation	
2.2 Mechanical connections	04
2.3 Compressed air connection	05
2.4 Electrical connection	
3. Circuit diagram and function diagram	05
4. Utilization	06
4.1 General instructions	
4.2 Putting into operation	
4.3 Normal operation	
4.4 Inexpert handling	
5. Maintenance and servicing	06
5.1 General information	
5.2 Maintenance	
5.3 Servicing	
6. Storage	06
7. Disposal	06
8. Spare parts	07

- Read and follow these safety instructions first and take notice of the operating instructions.

Safety instructions

1. The installation, maintenance, initial operation, removal and repair has to be carried out by qualified experts with knowledge about electrical equipment and know-how about handling of pressure equipment and pneumatic pressure units.
2. The statutory and other applicable regulations and standards have to be noticed and kept.
3. Comply with the specifications on the data plate.
4. The pressure and temperature details given by the data plate have to be kept.
5. A fuse (with max. 4 A) has to be connected in series to the supply voltage of the control valve.
6. A pressure-reducing valve has to be installed in the control pressure supply line and it has to be set at the given control pressure.
7. The process pressure (delivery pressure) and the control pressure given by the type plate must not be exceeded.
8. Initial operation and pressure admission only when the silo filling device is completely installed.
9. When the silo filling device is damaged the compressed air and voltage supply has to be shut off immediately and it is to released from any pressure e.g. by removal of the control medium conveying line.
10. Any work at the filling device has to be carried out in pressure-free and de-energized condition only.
11. Read and follow the attached safety instructions for the single units.



12. By usage in explosive hazardous areas read and follow the enclosed safety instructions of the operating instructions and the explosive protection informations of the single units.

Operating instructions

1. Specification

1.1 Extent of delivery

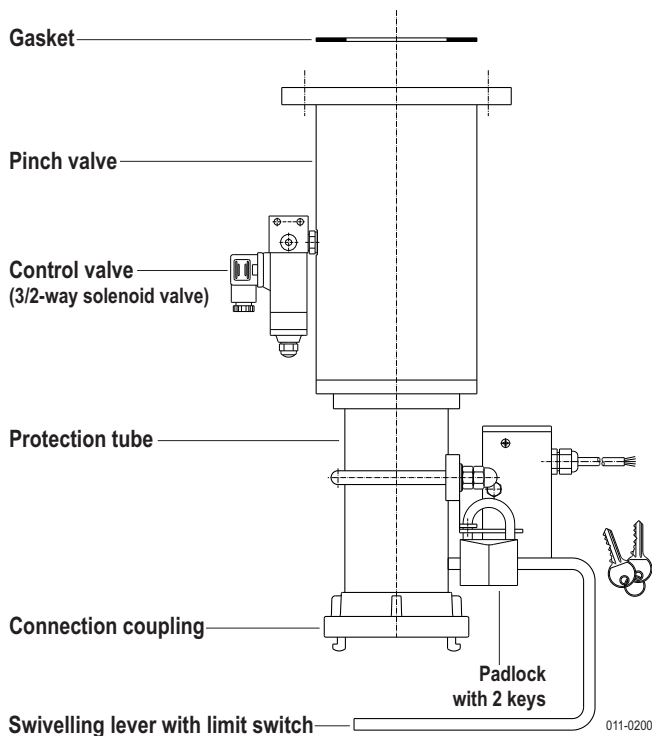

Extent of delivery is depending on the choice of options.

1.2 Intended use

The device is to be mounted at the filling pipe of silos, which were filled pneumatically by a silo vehicle, to connect the filling hose, for contacting and to shut-off the filling pipe. In its capacity as part of the silo filling device, the pinch valve is designed, build and approved as a „pressure-maintaining component“ in accordance to the Pressure Equipment Directive 2014/68/EU.

1.3 Function

The swivelling lever has to be swivelled aside to connect the filling hose to the coupling. The limit switch, which is integrated in the swivelling lever, signalizes to the control unit that a hose has been attached.

The pinch valve will be actuated by compressed air via a control valve (Solenoid valve). The pinch valve is closed when de-energized.

1.4 Technical data

Manufacturer	MOLLET
	Füllstandtechnik GmbH
Address	Industriepark RIO 103 74706 Osterburken
Name	Silo filling device
Type	SFA-Q ...
Process temperature	$T_{(Process)}$ -25 °C ... +80 °C
Ambient temperature	T_a -20 °C ... +40 °C
Supply voltage	
Control valve last digit 1	230 V AC 50 ... 60 Hz
Control valve last digit 2	24 V DC
Control valve last digit 3	24 V AC
Signal contact of the swivelling lever	} see type plate and appendixes to the operating instructions
Switching ability	
Switching voltage	
Type of protection	IP IP65 according to DIN EN 60529
Process pressure	$p_{(Process)}$ 2.0 bar ... 2.5 bar
Delivery air pressure	
Control pressure	4.5 bar ... 5.0 bar Compressed air, oil and water-free
Weight	
DN065	15.0 kg
DN080	15.5 kg
DN100	19.8 kg
	} completely assembled
Mounting position	vertical to horizontal
1.5 Materials	depending on choice of option
Pinch valve	Housing Aluminium Clamping sleeves Aluminium or stainless steel Hose NR Caoutchouc, resistant to abrasion, Hose NW Caoutchouc, inside white for food Hose NRE Caoutchouc conductible, (for ATEX valves)
Protection tube	Steel, galvanized or stainless steel
Swivelling lever	Steel, galvanized
Connection coupling	Aluminium or stainless steel

2. Installation

2.1 Preparation

- Before starting to work at the silo filling device read and follow the safety instructions and the operating instructions!
- The silo filling device is completely assembled with control valve, swivelling lever with limit switch and connection coupling.
- Remove the weld-on flange and the sealing. (Put screws and washers aside)
- To avoid damaging the silo filling device don't carry out welding works at or nearby the filling device.

2. Continuation installation

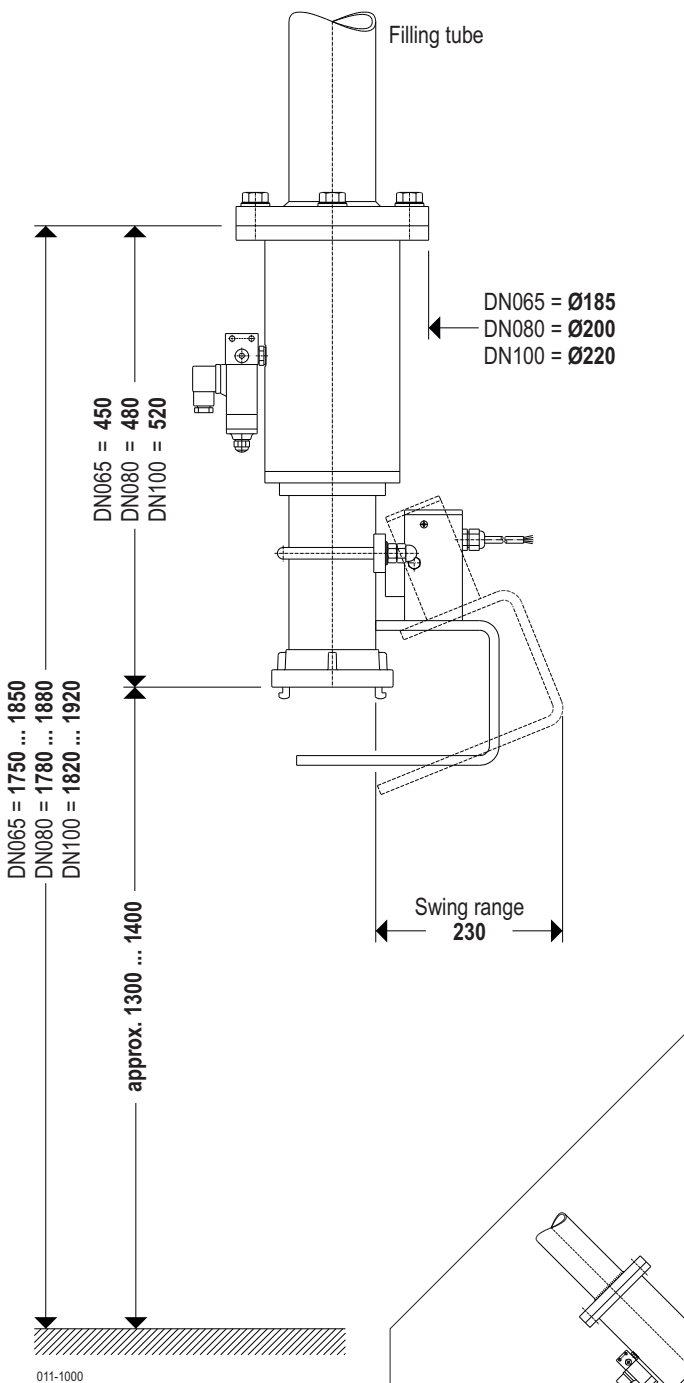

2.2 Mechanical connections

a Push the weld-on flange on the tube.

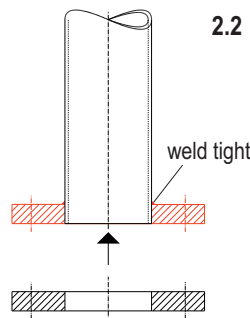

b Adjust the boreholes of the flange as shown here and weld the flange in this position.

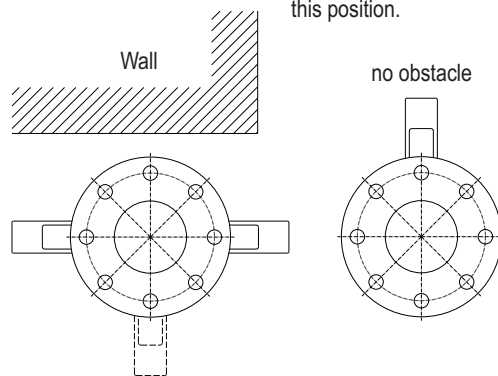

011-1001

c Put the sealing at the flange of the silo filling device and fasten it on in such way that, if a wall is behind it, the swivelling lever points to the right, to the left or to the front or, if no obstacle is present, backwards.

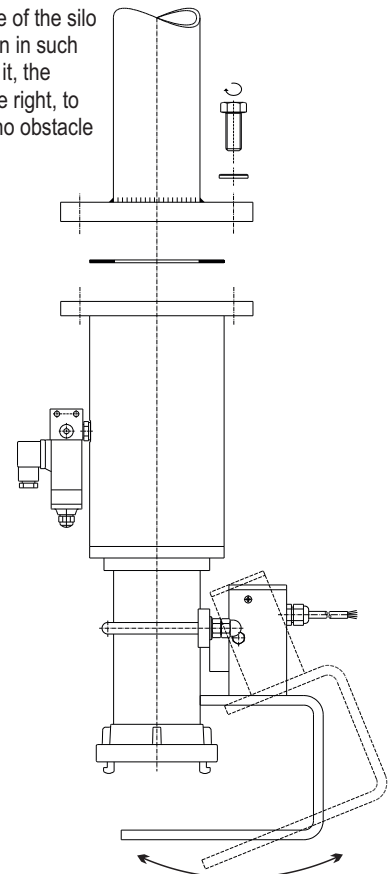

The swivelling lever has to swivel freely.

011-1003

d In case of slanting or horizontal pipe the silo filling device has to be mounted always on the upper side, the lever must fall into the final position by its own weight.

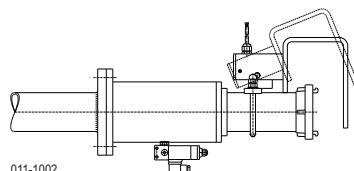

2.3 Compressed air connection

- Connect the control valve with the oil and water-free compressed air supply by a weather-resisting hose.
- Adjust the pressure reducing valve at 4.5 bar ... 5.0 bar.

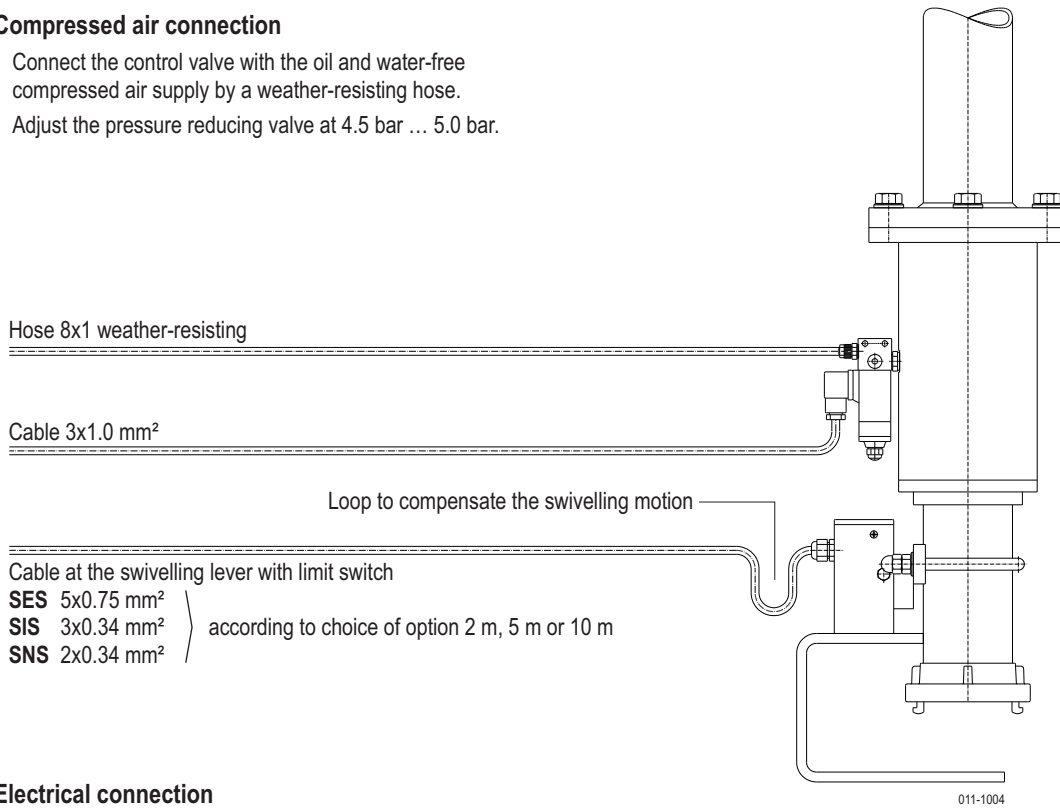

2.4 Electrical connection

- Connect the control valve with the control cabinet according to the local and statutory rules and regulations.
- Subsequently connect the cable of the swivelling lever with limit switch with the assigned terminal of the control cabinet.

3. Circuit diagram and function diagram

Control pressure 4.5 bar ... 5.0 bar
Compressed air oil and water-free
Compressed air consumption
per switching function

DN065 = 5.4 NI
DN080 = 6.8 NI
DN100 = 8.0 NI

Swivelling lever with limit switch according to choice of option

SNS

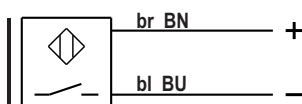

011-AP02

SIS

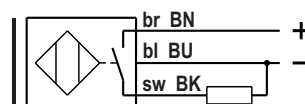

011-AP01

SES

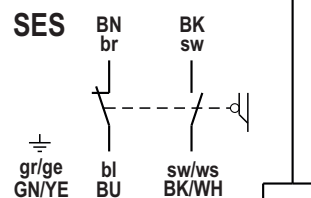

011-AP00

011-AP03

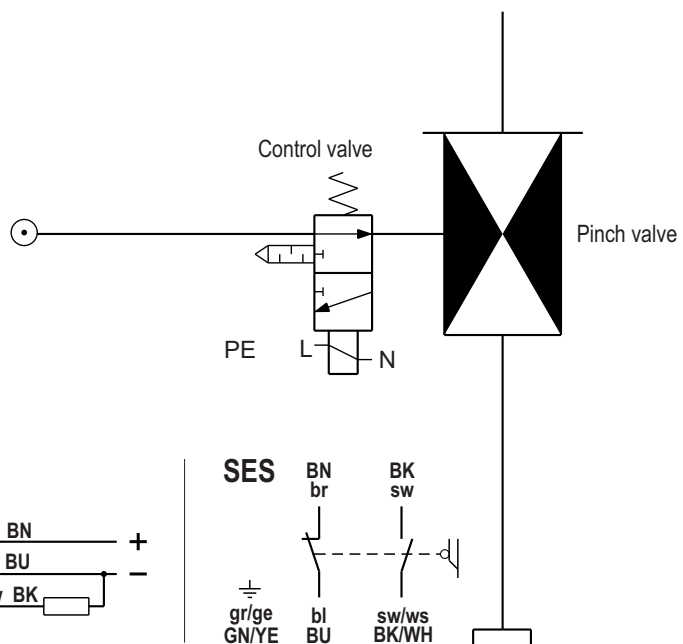

4. Utilization

4.1 General instructions

- The silo filling device with its equipment may be operated and monitored by expert and instructed personnel only so that employees and other persons will not be brought in danger.
- The operating instructions with the safety instructions have to be available to the operating and maintenance personnel.
- In its capacity as part of the silo filling device, the pinch valve is a „pressure-maintaining component“ in the meaning of the Pressure Equipment Directive 2014/68/EU. Therefore take care of the country of installation's national regulations about the operation of pressure equipment.

4.2 Putting into operation

Put the silo filling device in operation only when:

- The silo filling device is fix connected with the filling pipe,
- a pressure reducing valve is mounted at the compressed air supply pipe and the control pressure is adjusted,
- the electrical connections are done correctly and
- the swivelling lever can swivel freely, the connecting cable is laid out flexible and can't be damaged by the motion.

4.3 Normal operation

- Use the silo filling device in its intended application only.
- Keep the safety instructions of all units.
- If the silo filling device is damaged put it out of operation immediately and relieve it from any pressure.
- If the maximum permissible pressure or temperature was exceeded check the hose of the pinch valve.

4.4 Inexpert handling

- Ignoring the safety instructions and the operating instructions.
- Not intended use.
- Operating of the pinch valve by personnel which is not authorized or not proper instructed.
- Mounting of spare parts which are no original parts.
- Violation against applicable law and standards.

5. Maintenance and servicing

5.1 General information

- Carry out maintenance and repair work only when the silo filling device is disconnected from the control pressure and voltage supply lines and released from any pressure.
- If it's to reckon with the exhaust of hazardous substances during the maintenance special protection measures (e.g. personal protection equipment) are necessary.

5.2 Maintenance

Inspect in regular intervals:

- The correct pre-set of the pressure-reducing valve in the compressed air supply line,
- the hose of the pinch valve for tear and wear,
- all connections and joints for tight fit,
- the swivelling lever with limit switch for freedom of movement.

Schedule the inspection intervals according to

- the kind of material which has to be shut off and it's abrasiveness,
- the frequency of use but at least once a year.

5.3 Servicing

- Damaged parts have immediately replaced with similar.
- The silo filling device must not be used until the complete restoration of the proper function.

6. Storage









- Store the silo filling device dry and dust-free.
- When the storage period lasts longer than 4 weeks the openings of the silo filling device have to be closed with appropriate means (e.g. blank cap or blind flange) to protect the rubber hose from pollution.

7. Disposal

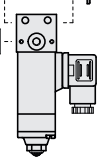
- The silo filling device can be recycled.
- The disposal applies to the valid environmental guidelines according to the location of the carrier and the local manufacturing conditions.

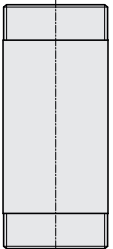
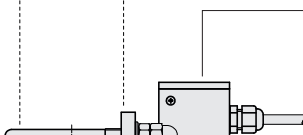
Spare parts

Silo filling device with pich valve
Type SFA-Q ... DN 65, 80 and 100

	DN 65	DN 80	DN 100
 Gasket	077-002-DIR-ABF	090-002-DIR-ABF	115-002-DIR-ABF
 Hexagonal nut	0934-05-000-STV	0934-05-000-STV	0934-05-000-STV
 Cylinder head screw	0912-05-045-STV	0912-05-045-STV	0912-05-045-STV
 3/2-way solenoid valve with all components	230 V AC 0 820 005 250B 24 V DC 0 820 005 251B 24 V AC 0 820 005 253B		
 Pinch valve depending on version	QV-065-FG-AX-XX	QV-080-FG-AX-XX	QV-100-FG-AX-XX
 Threaded pin	0914-06X010-V4A	0914-06X010-V4A	0914-06X010-V4A
 Double nipple in Steel, galvanized in 1.4571 / 316 Ti	065-200-NIP-STV 065-200-NIP-V4A	080-200-NIP-STV 080-200-NIP-V4A	100-200-NIP-STV 100-200-NIP-V4A
 Swivelling lever with integrated limit switch	SES-065-X SIS-065-X SNS-065-X	SES-080-X SIS-080-X SNS-080-X	SES-100-X SIS-100-X SNS-100-X
2=2 m, 5=5 m, 0=10 m Cable length			
 Padlock with 2 keys	KS-VS025-G, or optional KS-VS025-U,	the same key for all locks a separate key for every lock	
 Thread pin	0914-05X010-V4A	0914-05X010-V4A	0914-05X010-V4A
 Connection coupling in Aluminium in Aluminium /1.4581 / 318 in 1.4581 / 318	K-FSZ075IG2½-AL K-FSZ075IG2½-VA	K-FSZ075IG3-AL K-FSZ075IG3-VA	K-FSZ110IG4-AL K-FSZ110IG4-AV K-FSZ110IG4-VA

011-0800

Notes

A large grid area for taking notes, consisting of a 30x30 grid of small squares, occupying the majority of the page below the 'Notes' header.