

► Read and follow these safety instructions first and take notice of the operating instructions.

Safety instructions

1. The installation, initial operation and maintenance may be done by a qualified expert with electrical know-how only.
2. Comply with the local and statutory rules and regulations and/or the VDE 0100.
3. Take notice of the temperature specifications at the data plate.
4. A fuse (with max. 4A) has to be connected in series to the voltage supply.
5. Protect the signal contact from voltage peaks when inductive loads are connected.
6. The device may put into operation only if it is closed.
7. Switch off the power supply, before opening the device. (touchdangerous voltage)
8. Tear-off danger! Don't pour on the measuring cone. In case of full indication the filling process has to be stopped immediately.

Operating instructions

1. Description

1.1 Intended use

The level indicator observes the filling level as a limit switch in silos and vessels. It can be used as full and empty indicator for dusty and powdery, granulated and grainy bulk goods with a max. grain size up to 100 mm and with a bulk density of 0.3 t/m³ ... 3.0 t/m³.

1.2 Function

Bulk goods, being dumped besides the pendulum, are moving the pendulum more and more aside, as the filling level increases. A signal switch registers this movement and evaluates it.

1.3 Technical data

Manufacturer	MOLLET Füllstandtechnik GmbH
Address	Industriepark RIO 103 74706 Osterburken
Name	Pendulum level indicator
Type	PF
Bulk good temperature T_s	-25 °C ... +80 °C
Ambient temperature T_a	-20 °C ... +70 °C
Signal contact	change-over contact, potentialfree
Capacity of the contact	contact 4 A / 250 V AC
Switching voltage	24 V ... 250 V AC or 12 V ... 125 V DC
Response delay	none
Cable connection	Screw M4
Cable entry	cable gland M20x1.5
Type of protection	IP IP66 acc. to DIN EN 60529
Overpressure safety	up to 0.5 bar
Weight	1.15 kg
Maintenance	none
Mounting position	vertical, ± 3° inclination

1.4 Materials

Housing	GAL, RAL7001 coated
Folding bellow	NBR, black
Buckling protector	Stainless steel 1.4301 / 304
Rod	Aluminium or 1.4301 / 304
Sensor (Cone)	Aluminium or 1.4301 / 304

1.5 Dimensions

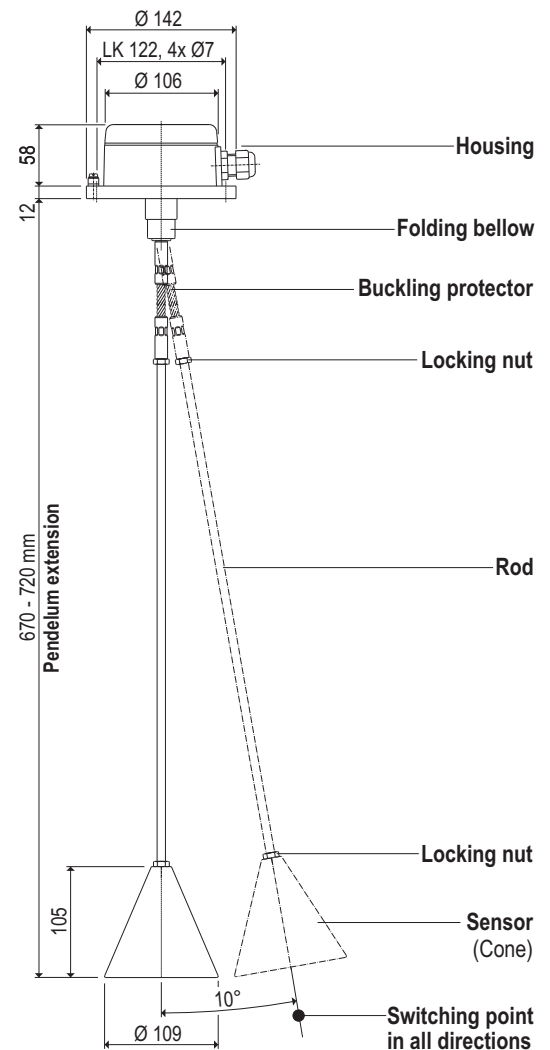

003-0200

2. Installation

2.1 Preparation

- Inspect if the delivery is complete.
The delivery consists of:
 - Housing with buckling protector
 - Rod with 2 locking nuts
 - Sensor (Cone)
- Read and follow the safety instructions and the operating instructions, before handling with the device !
- The pendulum has not to be struck by the filling stream.
- The pendulum must be able to swing unimpeded up to the switching point.

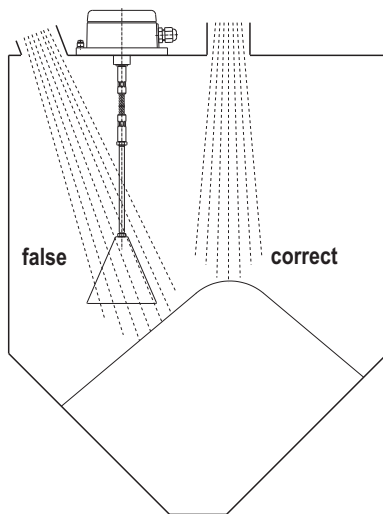

003-0701

2.2 Mounting of sensor (cone) and rod

- Screw the rod with the left and right screwed hexagonal nuts in the measuring cone and counter the nut with no. 13 open jaw wrench.
- Screw now this pendulum in the buckling protector and counter the nut with no. 10 and no. 13 open jaw wrench.
- If the pendulum has to be mounted from the inside of the vessel, than screw at first the housing at the connection flange and mount then the pendulum as described.

2.3 Mounting in the vessel

Position the level indicator with the gasket at the provided flange and fix it with 4 washers and screws M6.

2.4 Electrical connection

Circuit diagram

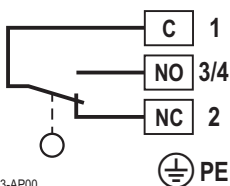

003-AP00



2.5 Cable gland

- After electrical connection, tighten the cable gland.
- Screw the cap nut, until the cable entry is closed tightly.

3. Commissioning

- Put the level indicator into operation only, if the installation and the electrical connection have been done correctly.
- The level indicator is presetted at sensitive.
- With the adjusting nut the device can be adjustable insensitive. Clockwise insensitive.

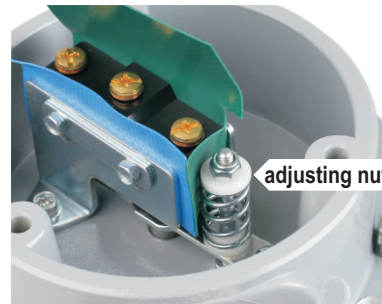

4. Utilization

4.1 Normal operation

- Use the level indicator in its intended application only.
- Comply with the specifications on the data plate.
- Damaged devices have to put out of operation immediately.

4.2 Inexpert handling

- Ignoring of the safety instructions and the operating instructions.
- Not intended use.
- Mounting of spare parts which are no original parts.
- Violation against applicable law and standards.

5. Maintenance and servicing

5.1 Maintenance

- The level indicator needs no maintenance.

5.2 Servicing

- Damaged parts have immediately replaced with similar.
- Until the complete reconstruction of the proper function, the level indicator must not be used any more.

6. Storage

- Store the level indicator dry and dust-free.
- Dismount the pendulum and store the housing on it's top.

7. Disposal

- The level indicator can be recycled.
- The disposal applies to the valid environmental guidelines according to the location of the carrier and the local manufacturing conditions.



Ersatzteile / Spare parts

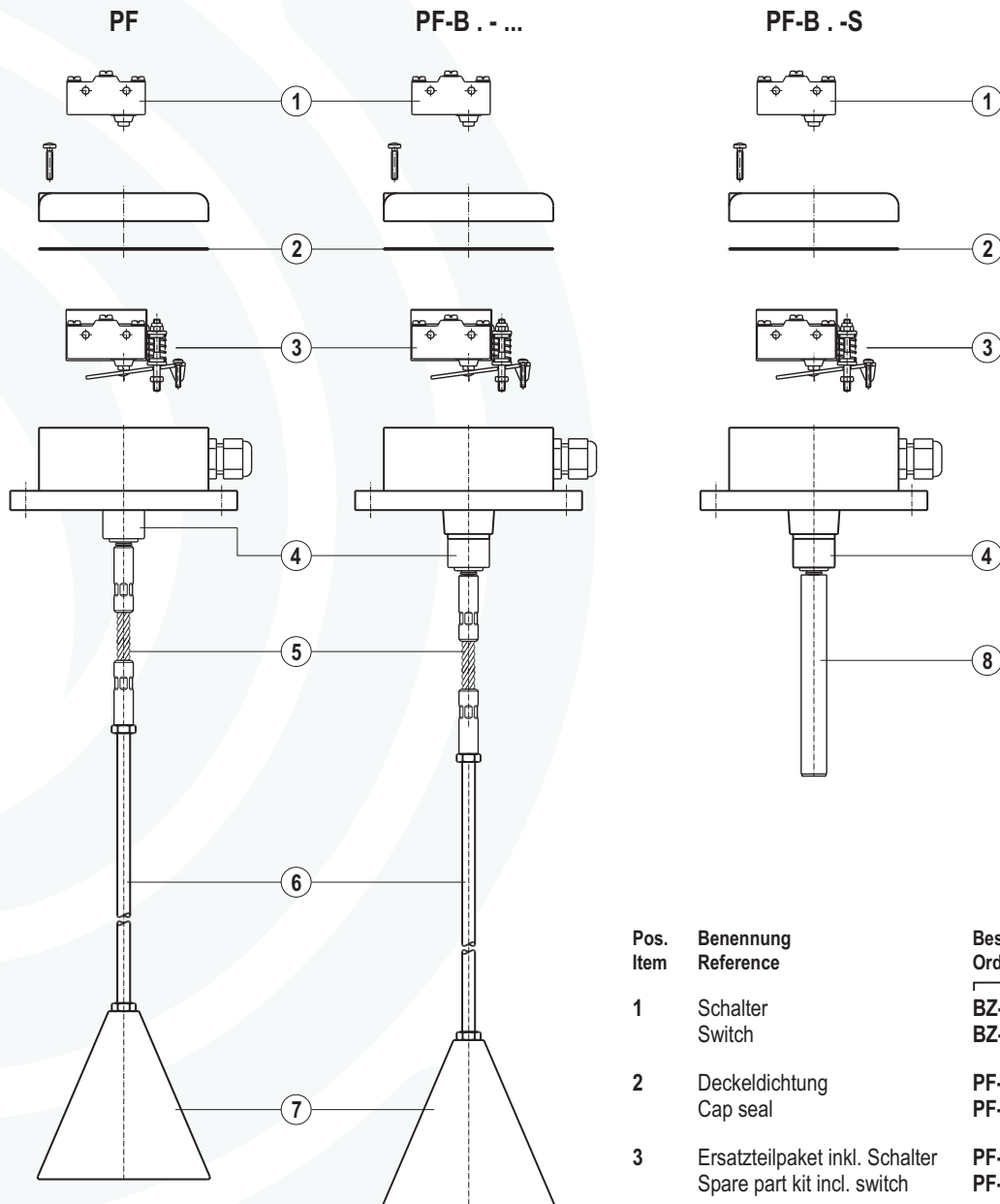

003-0800

Pos. Item	Benennung Reference	Bestellcode Order code	Werkstoff Material
1	Schalter Switch	BZ-2RD-A2 BZ-2RD-A2	
2	Deckeldichtung Cap seal	PF-DS001 PF-DS001	EPDM EPDM
3	Ersatzteilpaket inkl. Schalter Spare part kit incl. switch	PF-EP001 PF-EP001	
4	Faltenbalg Folding bellow	PF-FB001 PF-FB001	NBR NBR
5	Knickschutz Buckling protector	PF-KSD01 PF-KSD01	1.4301 / 304 1.4301 / 304
6	Pendel-Stab inkl. Muttern Pendulum rod incl. nuts	PF-WE005-AL PF-WE005-AL	Aluminium Aluminium
7	Tast-Fahne (Glocke) Sensor (Cone)	PF-KF-AL PF-KF-AL	Aluminium Aluminium
8	Pendel-Stab Pendulum rod	PF-ST-NR PF-ST-NR	NBR, mit Alukern NBR, with centre of aluminium



EU-Konformitätserklärung EU-Declaration of Conformity

Wir/We

MOLLET Füllstandtechnik GmbH

Industriepark RIO 103
D-74706 Osterburken
Tel. 06291 64400 Fax 06291 9846

erklären in alleiniger Verantwortung, dass das Produkt:
declares under our sole responsibility, that the product:

Pendel-Füllstand-Grenzscharter / Pendulum limit switch
Pendel-Füllstandanzeiger / Pendulum level indicator



Typ/Type **PF...**

den folgenden Europäischen Richtlinien entspricht:
conforms with the following European directives:

Niederspannungsrichtlinie **Low voltage directive** **2014/35/EU**

Angewandte harmonisierte Normen oder normative Dokumente:
Applied harmonized standards or normative documents:

EN 61010-1:2010 **EN 60529:1991 + A1:2000 + A2:2013**

Und die Geräte mit  - Kennzeichnung entsprechen zusätzlich der folgenden Europäischen Richtlinie:
And the devices with  - marking conform additional with the following European directive:

ATEX-Richtlinie **ATEX directive** **2014/34/EU**

Je nach Ausführungsvariante angewandte harmonisierte Normen oder normative Dokumente:
Depending on the design applied harmonized standards or normative documents:

EN 60079-0:2012 + A11:2013 **EN 60079-11:2012** **EN 60079-31:2014**

EG-Baumusterprüfbescheinigungsnummer:
EU-Type Examination Certificate:

IBExU05ATEX1174

Ausgestellt von:.
Issued by:

IBExU Institut für Sicherheitstechnik GmbH, 09599 Freiberg (0637)

Qualitätssicherung:
Quality assurance:

TÜV NORD CERT GmbH, 30159 Hannover (0044)

Osterburken, den 10.05.2016



Wolfgang Hageleit
Geschäftsführer / managing director

Diese Erklärung darf nur unverändert weiterverbreitet werden.
This declaration is only allowed to hand out in unchanged form.

