

► Read and follow these safety instructions first and take notice of the operating instructions.

## Safety instructions

1. The installation, initial operation and maintenance may be done by a qualified expert with electrical know-how only.
2. Comply with the local and statutory rules and regulations and/or the VDE 0100.
3. Take notice of the temperature specifications at the data plate.
4. A fuse (with max. 4A) has to be connected in series to the voltage supply.
5. Protect the signal contact from voltage peaks when inductive loads are connected.
6. The device may put into operation if it is closed, only.
7. Switch off the power supply, before opening the device. (touchdangerous voltage)
8. Attention safety device! Don't modify anything at the device or at the switching point adjusting!

## Operating instructions

### 1. Description

#### 1.1 Intended use

The pressure detector controls as limit switch the overpressure in silos and vessels.

#### 1.2 Function

If the pressure reaches the switching point **SP**, the pressure detector will give a signal.

#### 1.3 Technical data

Manufacturer	<b>MOLLET</b> Füllstandtechnik GmbH
Address	Industriepark RIO 103 74706 Osterburken
Name	Silo pressure detector
Type	<b>MSD-A . F1 .</b>
Bulk good temperature $T_s$	-25 °C ... +80 °C
Ambient temperature $T_a$	-20 °C ... +70 °C
Signal contact	change-over contact, potentialfree
Capacity of the contact	<b>contact</b> 4 A / 250 V AC
Switching voltage	24 V ... 250 V AC or 12 V ... 125 V DC
Switching point	<b>SP</b> 40 mbar = 0.04 bar = 400 mm WS
Overpressure safety	up to 0.5 bar
Cable connection	Scrwe M4
Cable entry	Cable gland M20x1.5
Type of protection	<b>IP</b> IP66 acc. to DIN EN 60529
Weight	1.2 kg
Maintenance	none
Mounting position	vertical, $\pm 5^\circ$ inclination

#### 1.4 Material

Housing	Aluminium or stainless steel 316
Flange	Aluminium or stainless steel 316 Ti
Membrane	Stainless steel 304
Flange socket	Steel

### 1.5 Dimensions

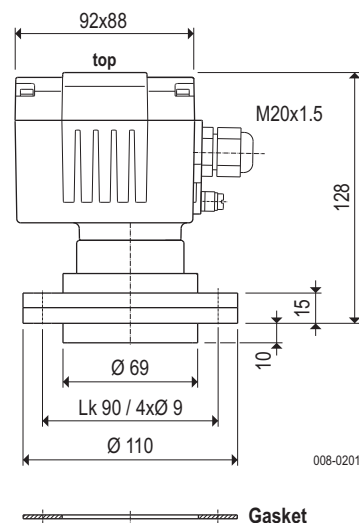

### 1.6 Accessory (Option) Flange socket

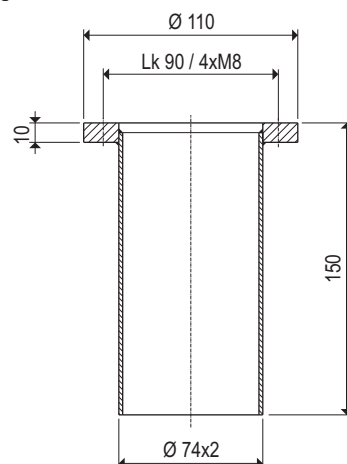

## 2. Installation

### 2.1 Preparation

- Check the membrane of visual transport damage.
- Read and follow the safety instructions and the operating instructions, before handling with the device !

### 2.2 Mounting in the vessel

- Weld the flange socket (as a option) vertical (Flange is horizontal) in the silo top.
- Position the pressure detector (Flange is horizontal) with the gasket at the provided flange or flange socket and fix it with 4 washers and screws M8.

### 2.3 Electrical connection

Circuit diagram

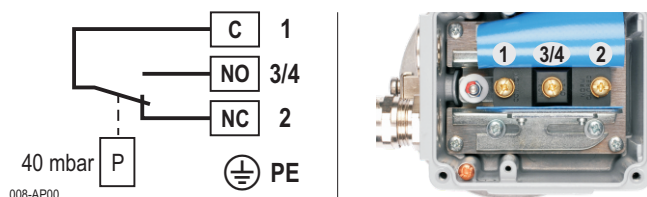

### 2.4 Cable gland

- After electrical connection, tighten the cable gland.
- Screw the cap nut, until the cable entry is closed tightly.

### 2.5 Cable run

Run the connection cable in a way that no traction can occur at the pressure detector.

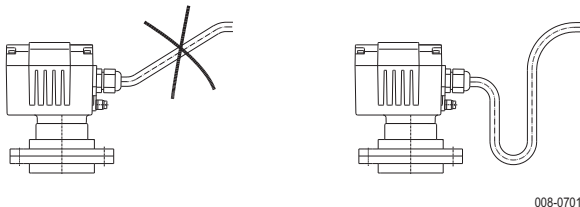

### 2.6 Switching point

- The switching point is adjusted at 40 mbar.
- A modification may be carried out by the manufacturer only.

## 3. Utilization

### 3.1 Commissioning

- Put the pressure detector into operation only, if the installation in the silo or vessel and the electrical connection have been done correctly.

### 3.2 Normal operation

- Use the pressure detector in its intended application only.
- Comply with the specifications on the data plate.
- Damaged devices have to put out of operation immediately.
- The pressure detector must not be modified. If there is any modification, the warranty of the manufacturer will be, cancelled.

### 3.3 Inexpert handling

- Ignoring of the safety instructions and the operating instructions.
- Not intended use.
- Modification at the device or of the switching point adjusting.
- Violation against applicable law and standards.

## 4. Maintenance and servicing

### 4.1 Maintenance

- In case of intended use, the silo pressure detector needs no maintenance.

### 4.2 Servicing

- The servicing of the pressure detector may be carried out by the manufacturer only.

## 5. Storage

- Store the pressure detector dry and dust-free.
- Protect the membrane from damage.

## 6. Disposal

- The pressure detector can be recycled.
- The disposal applies to the valid environmental guidelines according to the location of the carrier and the local manufacturing conditions.

## EU-Konformitätserklärung EU-Declaration of Conformity

Wir/We

**MOLLET Füllstandtechnik GmbH**

Industriepark RIO 103  
D-74706 Osterburken  
Tel. 06291 64400 Fax 06291 9846

erklären in alleiniger Verantwortung, dass das Produkt:  
declares under our sole responsibility, that the product:

### **Silo-Druckmelder / Silo pressure detector**



Typ/Type **MSD-A...**

den folgenden Europäischen Richtlinien entspricht:  
conforms with the following European directives:

**Niederspannungsrichtlinie Low voltage directive 2014/35/EU**

Angewandte harmonisierte Normen oder normative Dokumente:  
Applied harmonized standards or normative documents:

**EN 61010-1:2010 EN 60529:1991 + A1:2000 + A2:2013**

Und die Geräte mit  - Kennzeichnung entsprechen zusätzlich der folgenden Europäischen Richtlinie:  
And the devices with  - marking conform additional with the following European directive:

**ATEX-Richtlinie ATEX directive 2014/34/EU**

Je nach Ausführungsvariante angewandte harmonisierte Normen oder normative Dokumente:  
Depending on the design applied harmonized standards or normative documents:

**EN 60079-0:2012 + A11:2013 EN 60079-11:2012 EN 60079-26:2015**  
**EN 60079-31:2014**

EG-Baumusterprüfbescheinigungsnummer:  
EU-Type Examination Certificate:

**IBExU06ATEX1069**

Ausgestellt von:.  
Issued by:

IBExU Institut für Sicherheitstechnik GmbH, 09599 Freiberg (0637)

Qualitätssicherung:  
Quality assurance:

TÜV NORD CERT GmbH, 30159 Hannover (0044)

Osterburken, den 10.05.2016



Wolfgang Hageleit  
Geschäftsführer / managing director

Diese Erklärung darf nur unverändert weiterverbreitet werden.  
This declaration is only allowed to hand out in unchanged form.

