



By use in explosive hazardous areas read and follow the

special conditions and instructions for safe application

of the attached

explosive protection information

B1 / B5



first and take notice of the operating instructions.

Operating instructions

1. Description

1.1 Intended use

The pressure detector controls as limit switch the over pressure in silos and vessels.

1.2 Function

If the pressure reaches the switching point **SP**, the pressure detector will give a signal.

1.3 Technical data

Manufacturer	MOLLET Füllstandtechnik GmbH
Address	Industriepark RIO 103 74706 Osterburken
Name	Silo pressure detector
Type	MSD-A . F1 . B .
Bulk good temperature T_s	-25 °C ... +80 °C
Ambient temperature T_a	-20 °C ... +70 °C
Signal contact	change-over contact, potential free
max. switching voltage	see type plate
max. switching capacity	contact see type plate
Switching point	SP 40 mbar = 0.04 bar = 400 mm WS
Over pressure safety	up to 0.5 bar
Cable connection	Screw M4
Cable entry	Cable gland M20x1.5
Type of protection	IP IP66 acc. to DIN EN 60529
Weight	1.2 kg
Maintenance	none
Mounting position	vertical, $\pm 5^\circ$ inclination

1.4 Material

Housing	Aluminium or stainless steel 316
Flange	Aluminium or stainless steel 316 Ti
Membrane	Stainless steel 304
Flange socket	Steel

1.5 Dimensions

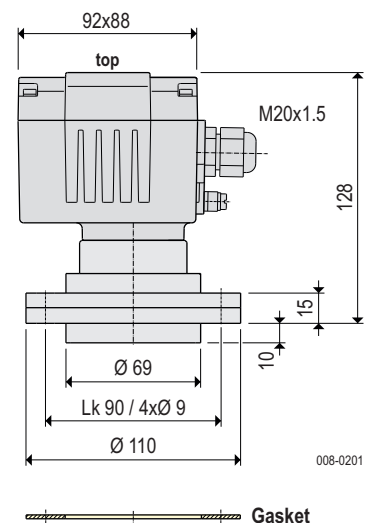

1.6 Accessory (Option) Flange socket

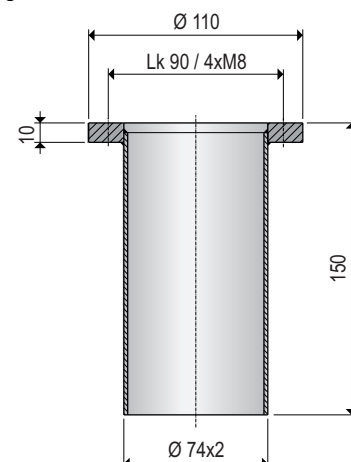

2. Installation

2.1 Preparation

- Check the membrane of visual transport damage.
- Read and follow the safety instructions and the operating instructions, before handling with the device !

2.2 Mounting in the vessel

- Weld the flange socket (as a option) vertical (Flange is horizontal) in the silo top.
- Position the pressure detector (Flange is horizontal) with the gasket at the provided flange or flange socket and fix it with 4 washers and screws M8.

2.3 Electrical connection

Circuit diagram

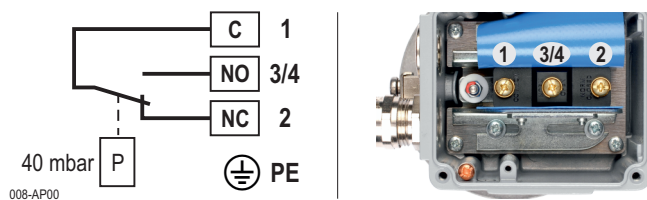

2.4 Cable gland

- After electrical connection, tighten the cable gland.
- Screw the cap nut, until the cable entry is closed tightly.

2.5 Cable run

Run the connection cable in a way that no traction can occur at the pressure detector.

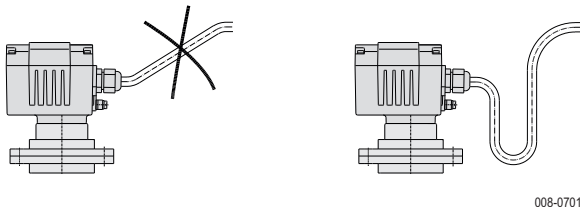

2.6 Switching point

- The switching point is adjusted at 40 mbar.
- A modification may be carried out by the manufacturer only.

3. Utilization

3.1 Commissioning

- Put the pressure detector into operation only, if the installation in the silo or vessel and the electrical connection have been done correctly.

3.2 Normal operation

- Use the pressure detector in its intended application only.
- Comply with the specifications on the data plate.
- Damaged devices have to put out of operation immediately.
- The pressure detector must not be modified. If there is any modification, the warranty of the manufacturer will be, cancelled.

3.3 Inexpert handling

- Ignoring of the safety instructions and the operating instructions.
- Not intended use.
- Modification at the device or of the switching point adjusting.
- Violation against applicable law and standards.

4. Maintenance and servicing

4.1 Maintenance

- In case of intended use, the silo pressure detector needs no maintenance.

4.2 Servicing

- The servicing of the pressure detector may be carried out by the manufacturer only.

5. Storage

- Store the pressure detector dry and dust-free.
- Protect the membrane from damage.

6. Disposal

- The pressure detector can be recycled.
- The disposal applies to the valid environmental guidelines according to the location of the carrier and the local manufacturing conditions.

Silo pressure detector
with aluminium housing

MSD-A

Gas+
Dust



Explosion protection information
and supplement to the operating instructions

Type plate details

Gas+Dust  and **hybrid mixtures**

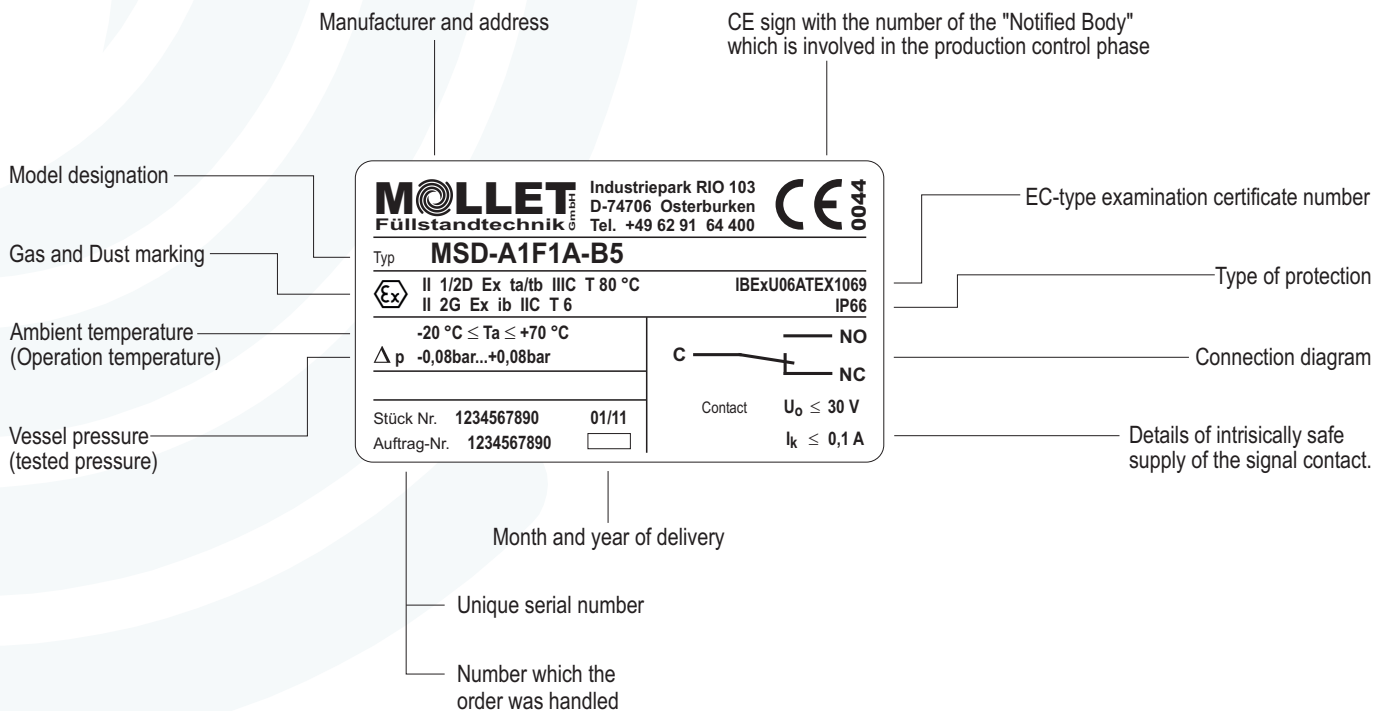

Marking in accordance with ATEX and DIN EN IEC 60079-0:2019

Silo pressure detector for use on the boundary from zone 20 to zone 21.

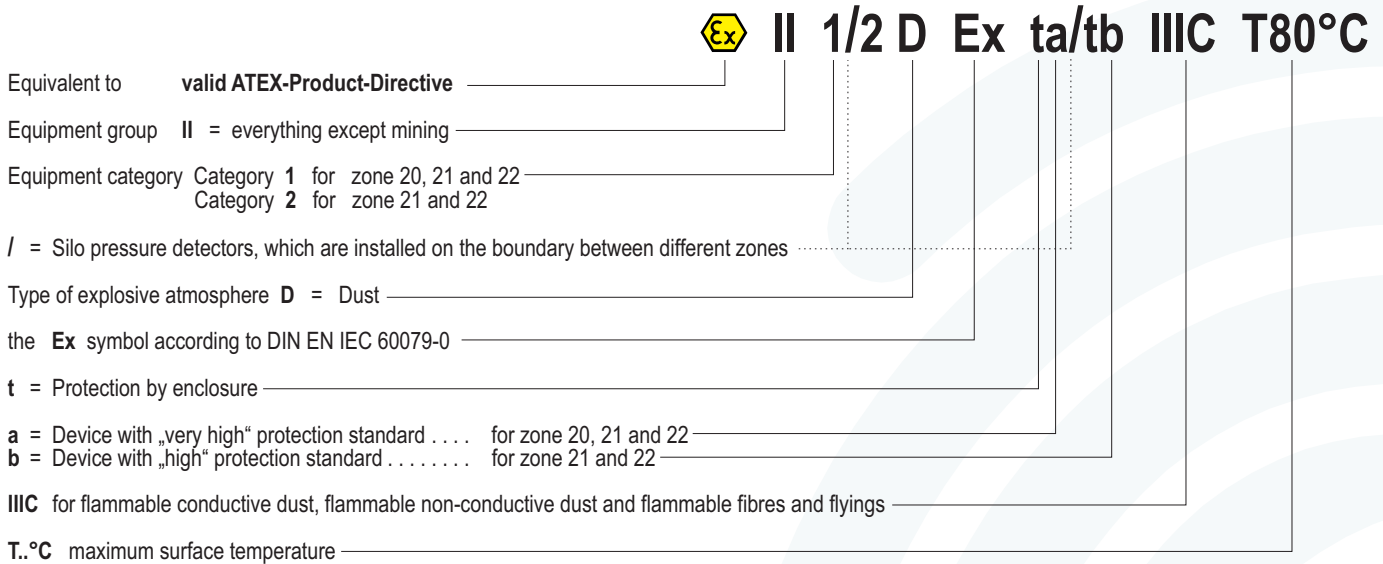

Silo pressure detector for use in zone 1

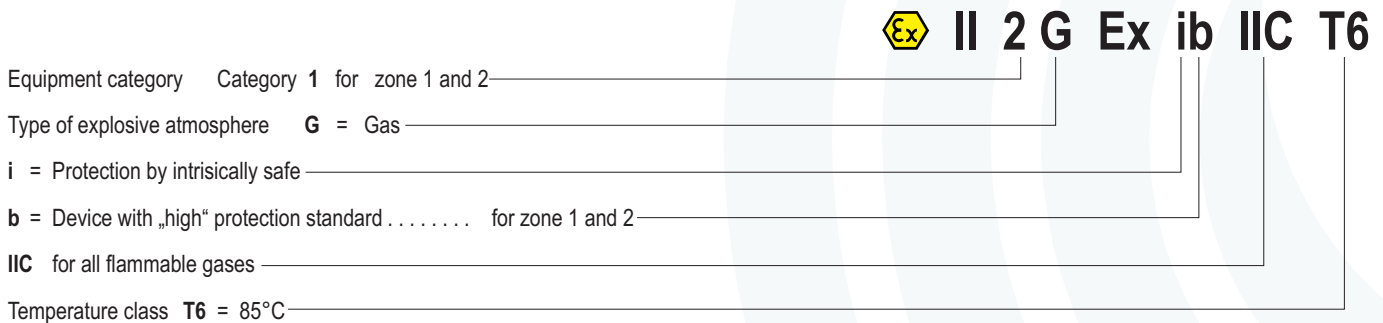

Silo pressure detector for use in zone 20.



Silo pressure detector for use in zone 0.

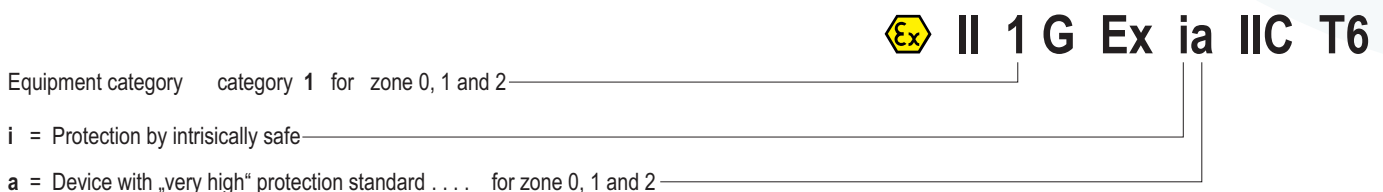

Order code **B5**

Marking: II 1D / 2D

II 2G

Gas+Dust  and **hybrid mixtures**

Equipment category appropriation by zones





Silo pressure detector for use in zone 1 and at the boundary from zone 20 to zone 21.

Ambient temperatures T_a

The ambient temperature T_a defines the maximum operating temperature of the detectors. Inside the vessel this is process temperature (the air or the bulk goods temperature) nearby the device.

maximum surface temperature T

The maximum surface temperature means the hottest point at the equipment. The device matches with temperature class **T6**.

 Industriepark RIO 103 D-74706 Osterburken Tel. +49 62 91 64 400		 0044
Typ MSD-A1F1A-B5		
 II 1/2D Ex ta/tb IIC T 80 °C	IBEU06ATEX1069 IP66	
 II 2G Ex ib IIC T 6		
$-20\text{ °C} \leq T_a \leq +70\text{ °C}$		
$\Delta p = -0,08\text{ bar} \dots +0,08\text{ bar}$		
Stück Nr. 1234567890 01/11	Contact  NO NC	
Auftrag-Nr. 1234567890	U ₀ ≤ 30 V I _k ≤ 0,1 A	

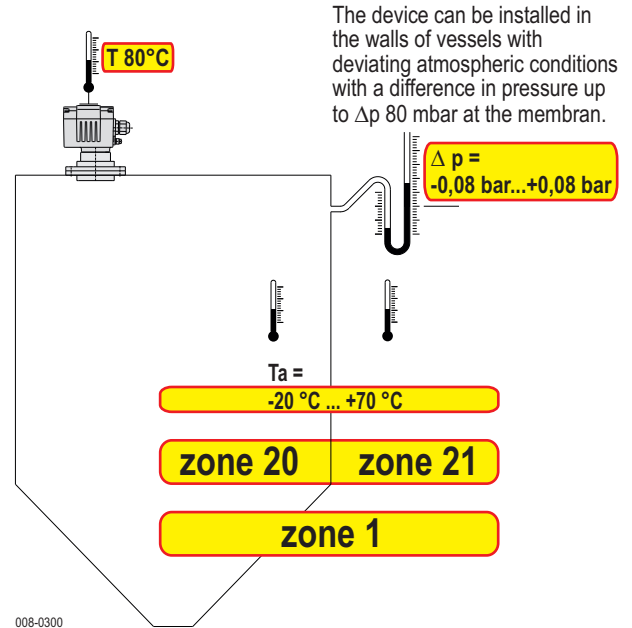

Order code **B22**

Marking: II 1D

II 1G

Gas+Dust  and **hybrid mixtures**

Equipment category appropriation by zones





Silo pressure detector for use in zone 0 and zone 20.

Ambient temperatures T_a

The ambient temperature T_a defines the maximum operating temperature of the detectors. Inside the vessel this is process temperature (the air or the bulk goods temperature) nearby the device.

maximum surface temperature T

The maximum surface temperature means the hottest point at the equipment. The device matches with temperature class **T6**.

 Industriepark RIO 103 D-74706 Osterburken Tel. +49 62 91 64 400		 0044
Typ MSD-A2F1I-B22		
 II 1D Ex ta IIC T 80 °C	IBEU06ATEX1069 IP66	
 II 1G Ex ia IIC T 6		
$-20\text{ °C} \leq T_a \leq +70\text{ °C}$		
$\Delta p = -0,08\text{ bar} \dots +0,08\text{ bar}$		
Stück Nr. 1234567890 01/11	Contact  NO NC	
Auftrag-Nr. 1234567890	U ₀ ≤ 30 V I _k ≤ 0,1 A	

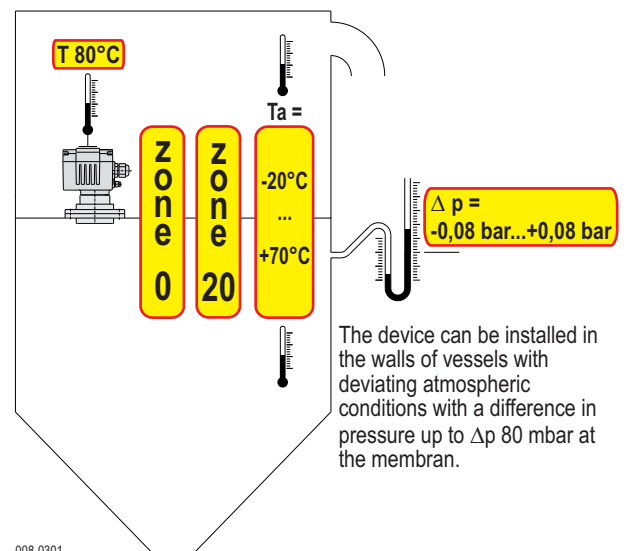



Special conditions and instructions for safe application

1. The installation, maintenance, initial operation, removal and repair have to be controlled resp. checked by an “authorized person” for explosion protection.
2. For the electrical connection you have to take notice of the local and statutory requirements and/or the VDE 0100.
3. Take notice of the specifications on the data plate.
4. **ATTENTION!** with design **B5**:
For load limitation a certified barrier or a certified isolation amplifier with an intrinsically safe circuit at least for the category “ib” has to be connected in series, witch is certified for gases of explosion group IIC.
4. **ATTENTION!** with design **B22**:
For load limitation a certified barrier or a certified isolation amplifier with an intrinsically safe circuit at least for the category “ia” has to be connected in series, witch is certified for gases of explosion group IIC.
5. As soon as the device will be brought into the explosion hazardous area it has to be mounted immediately at the precaused place and a cable has to be brought into the cable gland.
6. Using the device in ambient temperatures $> +60\text{ °C}$, the applied connection cables have to be made for temperatures of min. $+80\text{ °C}$.
7. The cable gland and the plug screw were screwed and protected at the factory. Please check if they have loosened during on the mounting or at the transport. When it is loosened, it has to be fitted again.
8. To secure the type of protection, the screw nut of the cable gland has to be fixed at the installation with a torsional force of min. 5.0 Nm.
ATTENTION! If it will be fastened too strong, the IP-protection can be affected.
9. The earth connection of the device has to be installed in such a way that mechanical damage will be excluded.
10. The device may put into operation with intact cap-sealing and when it is closed, only.
11. Switch off the power supply, before opening the device.
12. Using the Silo pressure detector in the silo wall under deviating atmospheric conditions the maximum differential pressure has not to exceed 80 mbar and the working temperature has not to exceed $+80\text{ °C}$ at the membran.
13. In case of existing combustible dusts with a minimum ignition energy less than 3 mJ or with a minimum ignition temperature under $+300\text{ °C}$ (BAM assessment), the parts in contact with the dust must be made of stainless steel.
14. In zone 0 all parts in contact with gas and dust must be made of stainless steel.
15. Take notice of the requirements of DIN EN 60079-14, DIN EN 60079-17 and DIN EN 1127-1, especially regarding the dust deposits and temperatures and follow the pertinent rules and regulations.
16. The device with an intrinsically safe electric circuit can be used in dusty explosive hazardous areas.
17. **Hybrid Mixtures**
The Silo pressure detector is approved for the use in hybrid mixtures.
18. **ATTENTION safety device!**
Don't modify anything at the device or at the switching point adjusting!

EU-Konformitätserklärung EU-Declaration of Conformity

Wir/We

MOLLET Füllstandtechnik GmbH

Industriepark RIO 103
D-74706 Osterburken
Tel. 06291 64400 Fax 06291 9846

erklären in alleiniger Verantwortung, dass das Produkt:
declares under our sole responsibility, that the product:

Silo-Druckmelder / Silo pressure detector



Typ/Type **MSD-A...**

den folgenden Europäischen Richtlinien entspricht:
conforms with the following European directives:

Niederspannungsrichtlinie **Low voltage directive** **2014/35/EU**

Angewandte harmonisierte Normen oder normative Dokumente:
Applied harmonized standards or normative documents:

DIN EN 61010-1:2011 **DIN EN 60529:2014**

Und die Geräte mit  - Kennzeichnung entsprechen zusätzlich der folgenden Europäischen Richtlinie:
And the devices with  - marking conform additional with the following European directive:

ATEX-Richtlinie **ATEX directive** **2014/34/EU**

Je nach Ausführungsvariante angewandte harmonisierte Normen oder normative Dokumente:
Depending on the design applied harmonized standards or normative documents:

DIN EN IEC 60079-0:2019 **DIN EN 60079-11:2012** **DIN EN 60079-26:2015**
DIN EN 60079-31:2014

EG-Baumusterprüfbescheinigungsnummer:
EU-Type Examination Certificate:

IBExU06ATEX1069

Ausgestellt von:.
Issued by:

IBExU Institut für Sicherheitstechnik GmbH, 09599 Freiberg (0637)

Qualitätssicherung:
Quality assurance:

TÜV NORD CERT GmbH, 30159 Hannover (0044)

Osterburken, den 10.02.2020



Wolfgang Hageleit
Geschäftsführer / managing director

Diese Erklärung darf nur unverändert weiterverbreitet werden.
This declaration is only allowed to hand out in unchanged form.