

Rotary blade level indicators

Level limit switches for bulk goods

DF

Gas+
Dust



Explosion protection information and supplement to the operating instructions

Index	Page
Marking in according to ATEX and DIN EN 60079	12
Details on type plate	13
Equipment category appropriation by zones	14
Ambient temperature T_a , maximum surface temperature T , TX in zone 0	15
Ambient temperature T_a	16
maximum surface temperature T	17
Pressure, vacuum Δp , p (process)	18
Zone separating, pressure and vacuum, outside non-hazardous-area	19
Special conditions and instructions for safe application	20
Complete installation inside the vessel	21

Marking in accordance with ATEX and DIN EN IEC 60079-0

Rotary blade level indicator as electrical device for use on the boundary from zone 20 to Zone 21.

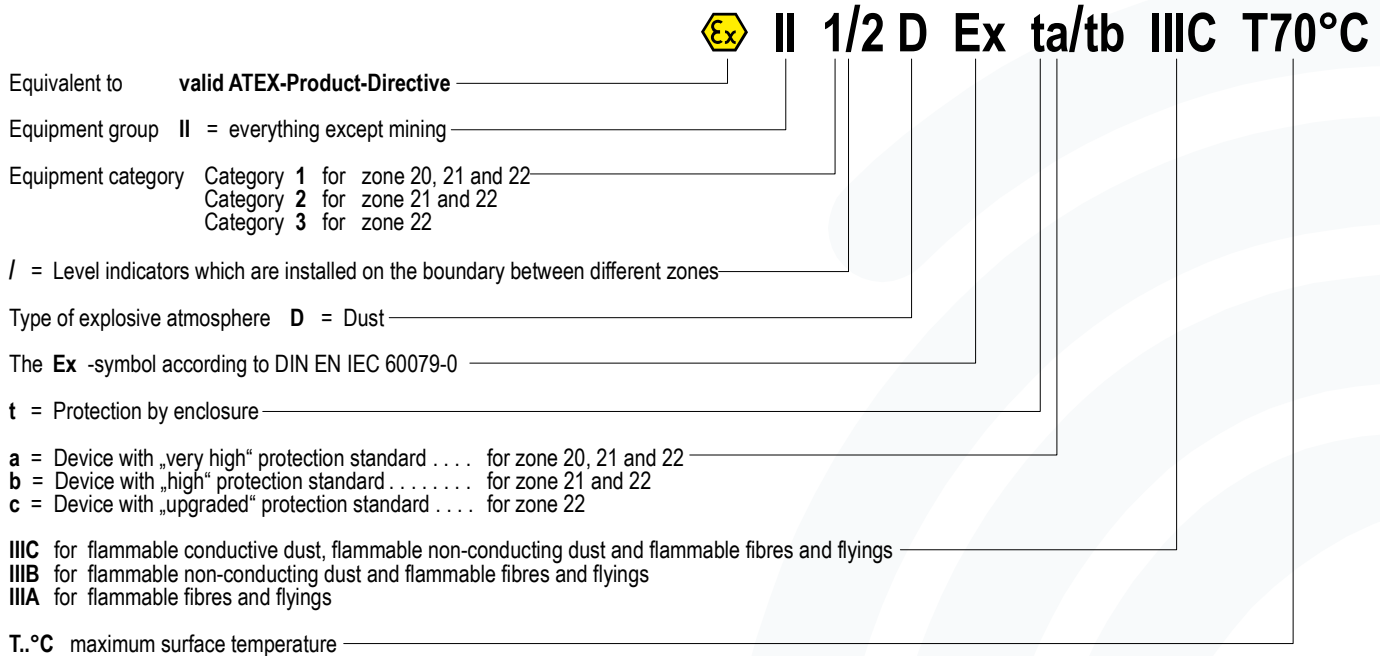

Rotary blade level indicators as electrical devices for use in zone 1.

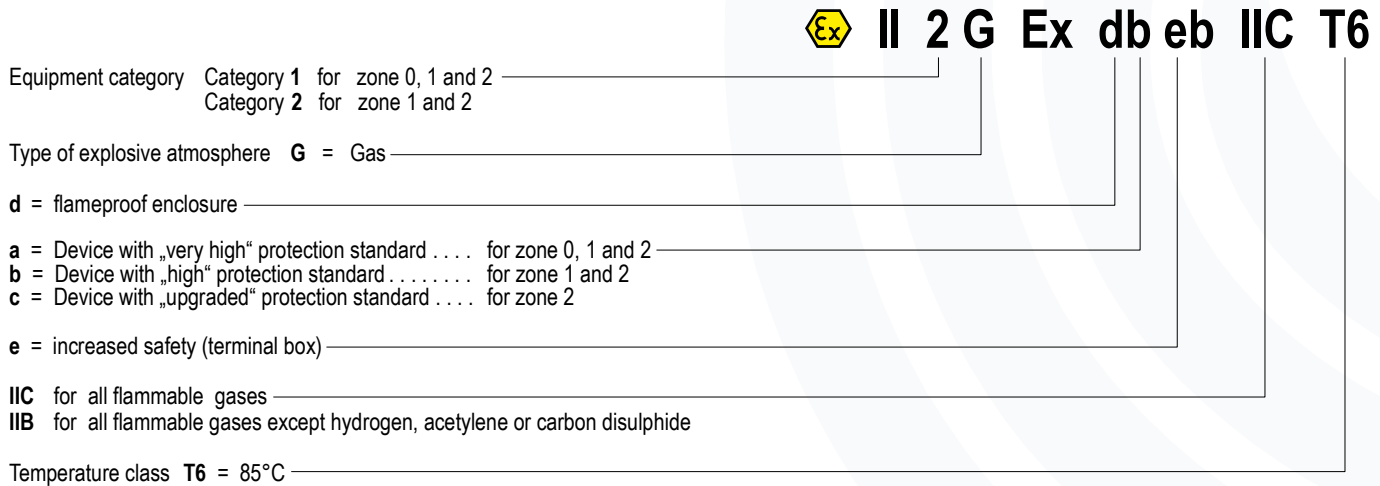

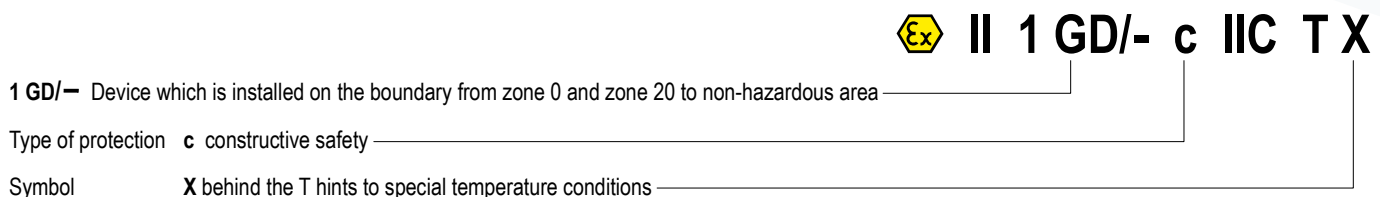

Zone separating element as non-electrical device for use on the boundary from zone 0 and zone 20 to non-hazardous area. for the installation of level indicators without ATEX certificate



Type plate details Gas+Dust and hybrid mixtures

Rotary blade level indicators as electrical device for use on the boundary from zone 20 to zone 21 and for use in zone 1.

Manufacturer and address	CE sign with the number of the "Notified Body", which is involved in the production control phase
Model designation	EC-type examination certificate number
Marking	Type of protection
Ambient temperature (Operation temperature)	Details of supply voltage and current consumption
Vessel pressure (tested pressure)	Details to loadability of the signal contact
 The device is suitable for the here stated vessel pressure	Please notice: Instructions for application can be filled in this field
	Month and year of delivery
	Unique serial number
	Number which the order was handled

MOLLET Füllstandtechnik GmbH Industriepark RIO 103 D-74706 Osterburken Tel. +49 62 91 64 400 

Typ **DF21A3B1C1G2AM1V**

 II 1/2D Ex ta/tb IIIC T70°C IBEXU04ATEX1033 X IP66
II 2G Ex db eb IIB T6

-20°C ≤ Ta ≤ +60°C	Supply 220...240V~ AC
Δ p -0,08bar...+0,08bar	50...60Hz 3,5VA
p (Process) -0,5bar...+5,0bar 	Contact 1mA 4V...2A 240V~

Stück Nr. **1234567890** 03/10
Auftrag-Nr. **1234567890**

Rotary blade level indicator as electrical device for use on the boundary from zone 0 and zone 20 to zone 1 and zone 21.

Model designation	EC-type examination certificate number
Marking	
Ambient temperature (Operation temperature)	
Permissible vessel pressure (tested pressure)	

MOLLET Füllstandtechnik GmbH Industriepark RIO 103 D-74706 Osterburken Tel. +49 62 91 64 400 

Typ **DF21A4CB1ZTP7C1G2AM1V**

 II 1D c TX/II 2D Ex tb IIIC T70°C IBEXU04ATEX1033 X IP66
II 1G c IIC TX/II 2G Ex db eb IIC T6

-25°C ≤ Ta ≤ +80°C / -20°C ≤ Ta ≤ +60°C	Supply 220...240V~ AC
p (Process) -0,9 bar ... +10,0 bar	50...60Hz 3,5VA
Stück Nr. 1234567890 03/10	Contact 1mA 4V...2A 240V~

Auftrag-Nr. **1234567890**

Zone separating element as non-electrical device for use on the boundary from zone 0 and zone 20 to non-hazardous area. for the installation of level indicators without ATEX certificate

Model designation	EC-type examination certificate number
Marking	
Ambient temperature (Operation temperature)	
Permissible vessel pressure (tested pressure)	

MOLLET Füllstandtechnik GmbH Industriepark RIO 103 D-74706 Osterburken Tel. +49 62 91 64 400 

Typ **DF-ZTCP7G2E**

 II 1GD/- c IIC T X IBEXU 04 ATEX 1001 X

-25°C ≤ Ta ≤ +80°C / -	
p (Process) -0,9 bar ... +10,0 bar	
Stück Nr. 1234567890 03/10	

Auftrag-Nr. **1234567890**

Note: the X behind the certification number indicates special conditions for the safe application of the equipment in the appendix to the EC-type examination certificate

Equipment category appropriation by zones

Installation on the boundary between different zones if zone 0 is inside.

Order code **A3B1ZTP7** or **A4B1ZTP7**

Marking:

II 1D / 2D



II 1G / 2G

and **hybrid mixtures**

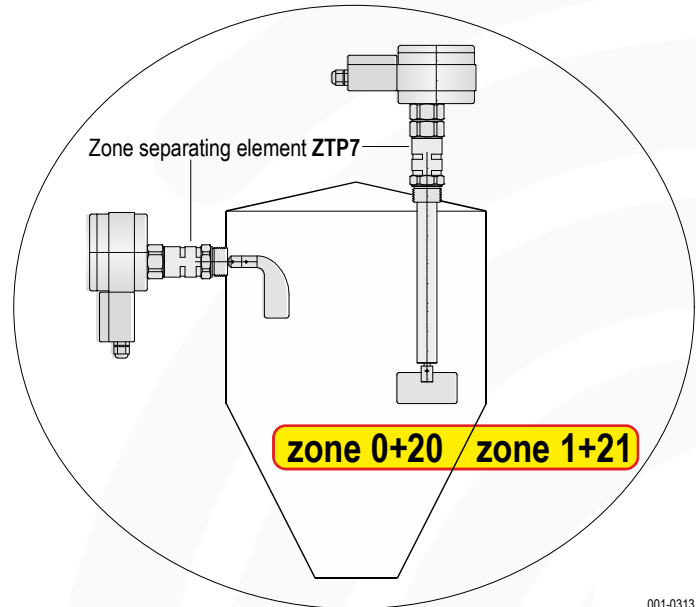

MOLLET Füllstandtechnik GmbH	Industriepark RIO 103 D-74706 Osterburken Tel. +49 62 91 64 400	CE 0044
Typ	DF21 A3B1ZTP7 C1G2AM2V	
	II 1D Ex ta/tb IIC T70°C II 1G Ex db eb IIB T6	IBExU04ATEX1033 X IP66
-25°C ≤ Ta ≤ +80°C / -20°C ≤ Ta ≤ +60°C	Supply	220...240V~ AC 50...60Hz 3,5VA
p (Process) -0,9bar...+10,0bar	Contact	1mA 4V...2A 240V~
Stück Nr. 1234567890	03/10	
Auftrag-Nr. 1234567890	<input type="checkbox"/>	

001-0313

Installation on the boundary between different zones.

Order code **A3** or **A4**

Marking:

II 1D / 2D



II 2G

and **hybrid mixtures**

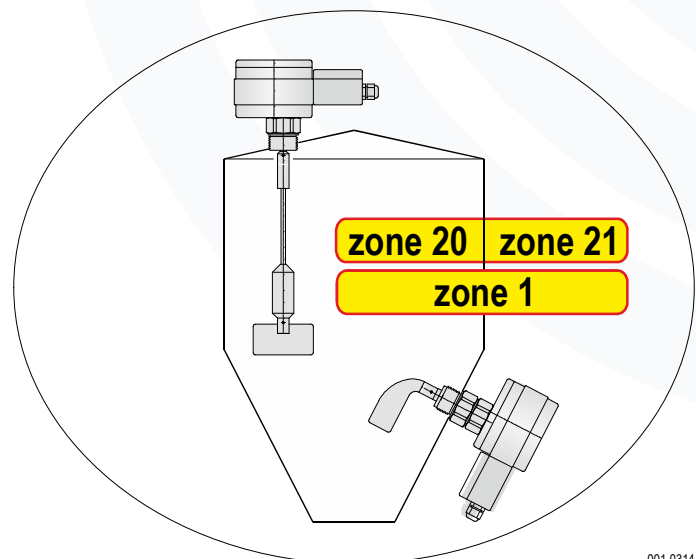

MOLLET Füllstandtechnik GmbH	Industriepark RIO 103 D-74706 Osterburken Tel. +49 62 91 64 400	CE 0044
Typ	DF23 A4B1 C1G2AM2V	
	II 1/2D Ex ta/tb IIC T80 °C II 2G Ex db eb IIB T6	IBExU04ATEX1033 X IP66
-20°C ≤ Ta ≤ +60°C	Supply	220...240V~ AC 50...60Hz 3,5VA
Δ p -0,08bar...+0,08bar	Contact	1mA 4V...2A 240V~
p (Process) -0,5bar...+5,0bar		
Stück Nr. 1234567890	03/10	
Auftrag-Nr. 1234567890	<input type="checkbox"/>	

001-0314

Ambient temperatures Ta If inside the vessel is zone 0.

The ambient temperature T_a defines the maximum operating temperature of the indicators.
Inside the vessel this is the air or the bulk goods temperature (Process temperature) nearby the device.

MOLLET Füllstandtechnik GmbH		Industriepark RIO 103 D-74706 Osterburken Tel. +49 62 91 64 400		CE 0044	
Typ DF21 A3B1ZTP7 C1G2AM2V					
Ex II 1D c TX/II 2D Ex tb IIC T70°C		IBExU04ATEX1033 X		IP66	
II 1G c IIB TX/II 2G Ex db eb IIB T6					
-25°C ≤ Ta ≤ +80°C / -20°C ≤ Ta ≤ +60°C		Supply 220...240V~ AC 50...60Hz 3,5VA			
p (Process) -0,9bar...+10,0bar		Contact 1mA 4V...2A 240V~			
Stück Nr. 1234567890 03/10					
Auftrag-Nr. 1234567890					

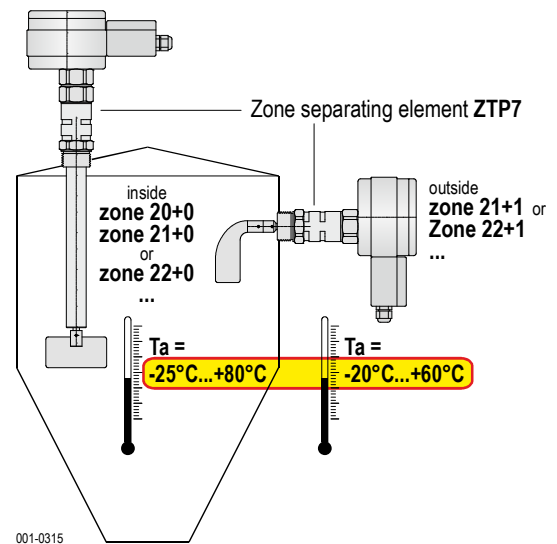

maximum surface temperature T, TX If inside the vessel is zone 0.

The maximum surface temperature means the hottest point that can occur at the equipment in the case of a fault.

Remark:

The surface temperature **TX** of the non-electrical part of the device (Jib and measuring blade) depends on the bulk goods temperature respectively the ambient temperature (Process temperature).
The non-electrical parts produce no hot surface by itself.

MOLLET Füllstandtechnik GmbH		Industriepark RIO 103 D-74706 Osterburken Tel. +49 62 91 64 400		CE 0044	
Typ DF21 A3CB1ZTP7 C1G2AR1M2V					
Ex II 1D c TX /II 2D Ex tb IIC T70°C		IBExU04ATEX1033 X		IP66	
II 1G c IIC TX /II 2G Ex db eb IIC T6					
-25°C ≤ Ta ≤ +80°C / -20°C ≤ Ta ≤ +60°C		Supply 220...240V~ AC 50...60Hz 3,5VA			
p (Process) -0,9bar...+10,0bar		Contact 1mA 4V...2A 240V~			
Stück Nr. 1234567890 03/10					
Auftrag-Nr. 1234567890					

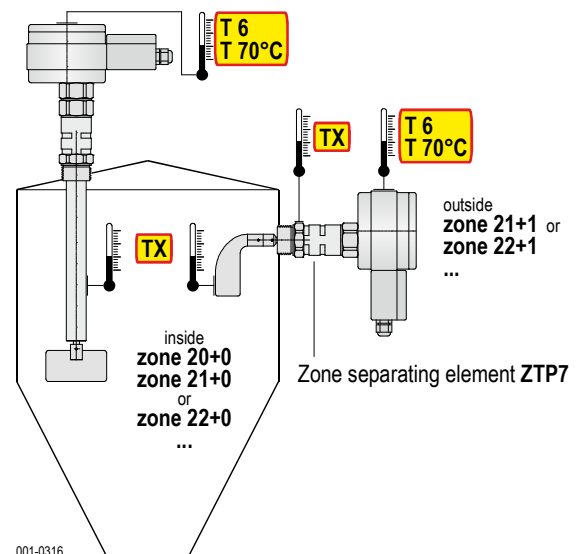

Ambient temperatures Ta Inside process temperature, outside ambient temperature.

The ambient temperature T_a defines the maximum operating temperature of the indicators.
Inside the vessel this is the air or the bulk goods temperature (Process temperature) nearby the device.

MOLLET Industriepark RIO 103 Füllstandtechnik GmbH D-74706 Osterburken Tel. +49 62 91 64 400		CE 0044
Typ DF23 A4B1 C1G2AM2V		
II 1/2D Ex ta/tb IIIC T70°C II 2G Ex db eb IIB T6		IBExU04ATEX1033 X IP66
-20°C ≤ Ta ≤ +60°C	Supply	220...240V~ AC
Δp -0,08bar...+0,08bar		50...60Hz 3,5VA
p (Process) -0,5bar...+5,0bar	Contact	1mA 4V...2A 240V~
Stück Nr. 1234567890 03/10		
Auftrag-Nr. 1234567890		

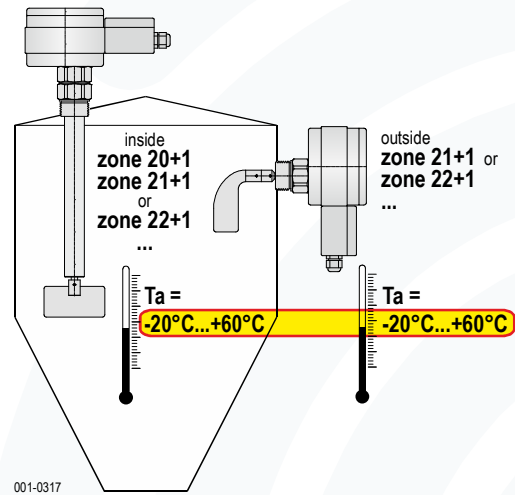

Ambient temperatures Ta Inside high process temperature, outside ambient temperature.

The ambient temperature T_a defines the maximum operating temperature of the indicators.
Inside the vessel this could be the ambient and/or the bulk goods temperature and therefore the process temperature.

The temperature decoupling bell housing works as a cooling lane.
A maximum of 80 °C are allowed to reach the control head.

MOLLET Industriepark RIO 103 Füllstandtechnik GmbH D-74706 Osterburken Tel. +49 62 91 64 400		CE 0044
Typ DF23 A4B1 C1 E1 G2AM2V		
II 1/2D Ex ta/tb IIIC T70°C II 2G Ex db eb IIB T6		IBExU04ATEX1033 X IP66
-40°C ≤ Ta ≤ +150°C / -20°C ≤ Ta ≤ +60°C	Supply	220...240V~ AC
Δp -0,08bar...+0,08bar		50...60Hz 3,5VA
p (Process) -0,5bar...+5,0bar	Contact	1mA 4V...2A 240V~
Stück Nr. 1234567890 03/10		
Auftrag-Nr. 1234567890		

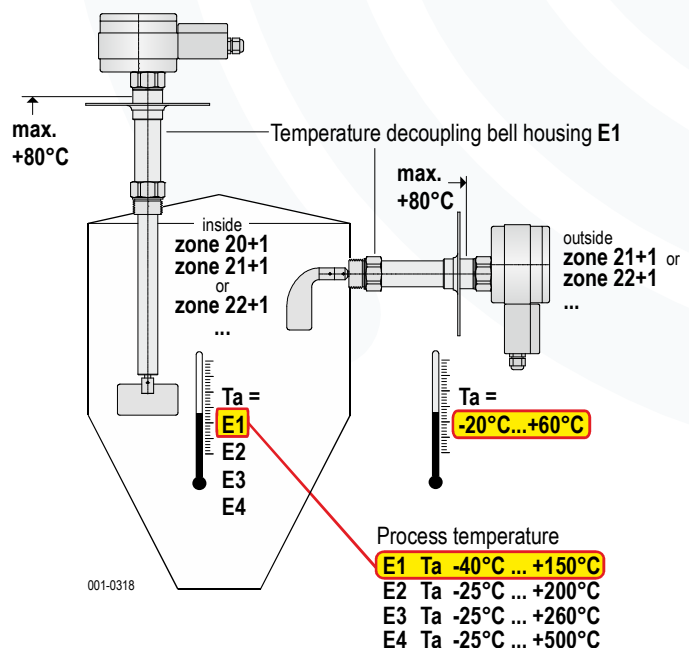

maximum surface temperature T Inside process temperature, outside ambient temperature.

The maximum surface temperature means the hottest point that can occur at the equipment in the case of a fault.

Remark:

The surface temperature of the non-electrical part of the device (Jib and measuring blade) depends on the process temperature (Bulk goods temperature respectively the ambient temperature)

The non-electrical parts produce no hot surface by itself.

MOLLET Industriepark RIO 103 Füllstandtechnik GmbH D-74706 Osterburken Tel. +49 62 91 64 400		0044
Typ DF23 A4B1 C1 G2AM2V		
Ex II 1/2D Ex ta/tb IIC T70°C II 2G Ex db eb IIB T6	IExU04ATEX1033 X IP66	
$-20^{\circ}\text{C} \leq T_a \leq 60^{\circ}\text{C}$ $\Delta p -0,08\text{bar} \dots +0,08\text{bar}$	Supply 220...240V~ AC 50...60Hz 3,5VA	
p (Process) -0,5bar...+5,0bar	Contact 1mA 4V...2A 240V~	
Stück Nr. 1234567890 03/10 Auftrag-Nr. 1234567890		

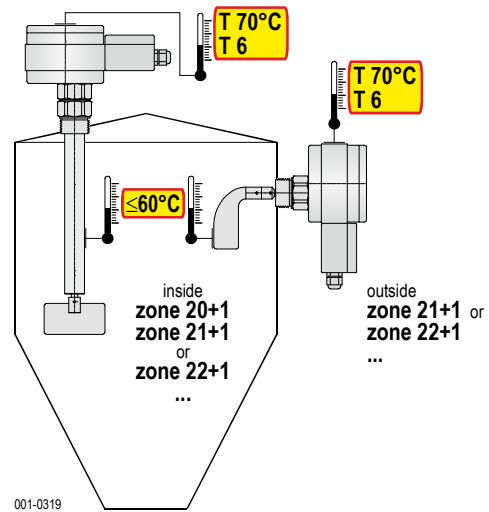

maximum surface temperature T Inside high process temperature, outside ambient temperature.

The **X** refers to hints in the EC-type-examination certificate:

The non-electrical part of the device (Jib, measuring blade and decoupling bell housing) produces no elevation of the temperature by itself, but can transfer high temperatures from inside the vessel. Because of this reason the surface temperature has to be defined according to the process temperature (Bulk goods temperature respectively the ambient temperature) from the interior of the vessel.

The temperature decoupling bell housing works as a cooling lane and emits heat.

MOLLET Industriepark RIO 103 Füllstandtechnik GmbH D-74706 Osterburken Tel. +49 62 91 64 400		0044
Typ DF23 A4B1 C1 E1 G2AM2V		
Ex II 1/2D Ex ta/tb IIC T70°C II 2G Ex db eb IIB T6	IExU04ATEX1033 X IP66	
$-40^{\circ}\text{C} \leq T_a \leq 150^{\circ}\text{C}$ $-20^{\circ}\text{C} \leq T_a \leq +60^{\circ}\text{C}$ $\Delta p -0,08\text{bar} \dots +0,08\text{bar}$	Supply 220...240V~ AC 50...60Hz 3,5VA	
p (Process) -0,5bar...+5,0bar	Contact 1mA 4V...2A 240V~	
Stück Nr. 1234567890 03/10 Auftrag-Nr. 1234567890		

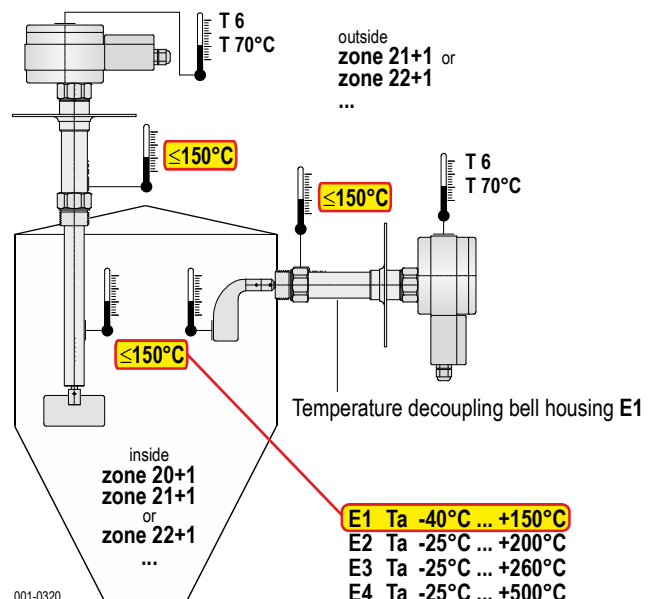

Pressure, vacuum Δp , p (Process)

High and low pressure in the case of deviations as well as in atmospheric and in non-atmospheric conditions.

The regulations, legislation and ordinances must be strictly observed when using rotary blade level indicators in vessels with high and low pressures.

The **X** refers to hints in the EC-type-examination certificate:

The device can be installed in the walls of vessels with deviating atmospheric conditions with a difference in pressure up to 80 mbar at the shaft passage.

MOLLET Industriepark RIO 103 Füllstandtechnik GmbH D-74706 Osterburken Tel. +49 62 91 64 400		0044
Typ DF23 A4B1 C1 P1 G2AM2V		
II 1/2D Ex ta/tb IIIC T70°C IBExU04ATEX1033 X II 2G Ex db eb IIB T6 IP66		
-20°C ≤ Ta ≤ +60°C		Supply 220...240V~ AC 50...60Hz 3,5VA
Δp -0,08bar...+0,08bar		Contact 1mA 4V...2A 240V~
p (Process) -0,5bar...+10,0bar		
Stück Nr. 1234567890 01/04		
Auftrag-Nr. 1234567890		

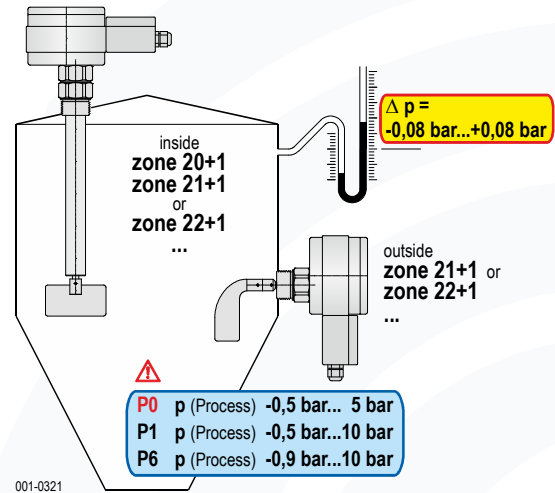

Please note!

The design of the devices is suitable for vessel pressures:

- 0,5 bar... 5 bar in version **P0 (Standard)**
- 0,5 bar...10 bar in version **P1**

These pressures are outside the atmospheric conditions defined by the directive 94/9/EG.

For pressures with the device models **P0**, **P1** and **P6** the EC-type-examination certificates are not valid. These devices are under the responsibility of the user (Please consider: There maybe national laws and regulations).

Pressure, vacuum p (Process) If inside is high process pressure.

Pressure decoupling bell housing P7

Pressure decoupling bell housings has to be used by vessel pressures above 0.08 bar.

The pressure decoupling bell housing **P7** is type examined and certificated for the use in explosive hazardous areas with pressures from -0.9 bar up to 10 bar.

MOLLET Industriepark RIO 103 Füllstandtechnik GmbH D-74706 Osterburken Tel. +49 62 91 64 400		0044
Typ DF23 A4B1 C1 P7 G2AM2V		
II 1D c TX/II 2D Ex tb IIIC T70°C IBExU04ATEX1033 X II 2G c IIB TX/II 2G Ex db eb IIB T6 IP66		
-25°C ≤ Ta ≤ +80°C / -20°C ≤ Ta ≤ +60°C		Supply 220...240V~ AC 50...60Hz 3,5VA
p (Process) -0,9bar...+10bar		Contact 1mA 4V...2A 240V~
Stück Nr. 1234567890 03/10		
Auftrag-Nr. 1234567890		

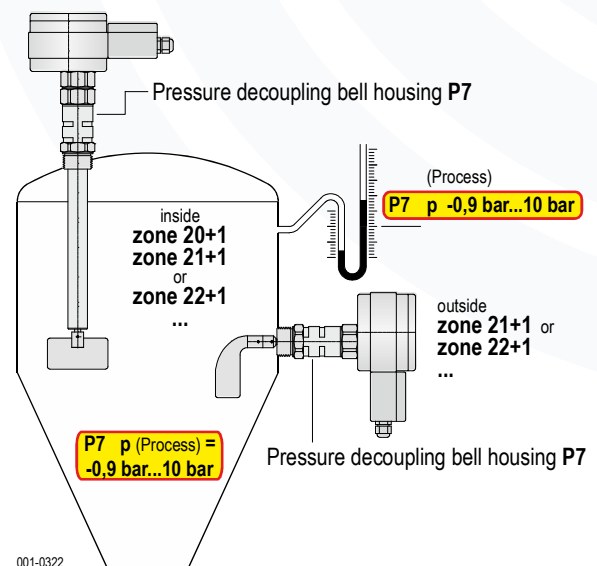



Zone separating, pressure and vacuum p (Process)

Inside the vessel zone 0 or zone 1, outside non-hazardous are, separation of the zones by zone separating element DF-ZTCP7.

The explosive hazardous area and the vessel pressure are separated from the non-hazardous area outside by the type examined zone separating element.

Within the non-hazardous area outside the vessel the control head can be used without ATEX certificate.

MOLLET Industriepark RIO 103 Füllstandtechnik GmbH D-74706 Osterburken Tel. +49 62 91 64 400		
Typ	DF-ZTCP7 G2E	
	II 1GD/- c IIC TX	IBExU 04 ATEX 1001 X
-25°C ≤ Ta ≤ +80°C / -		
p (Process) -0,9bar...+10,0bar		
Stück Nr.	1234567890	03/10
Auftrag-Nr.	1234567890	<input type="checkbox"/>

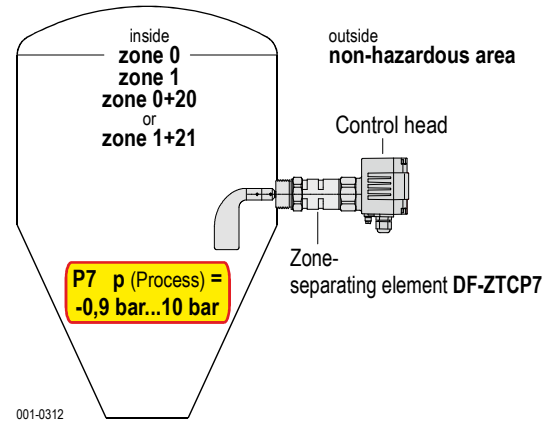



1. Special conditions and instructions for safe application

- 1.1 The installation, maintenance, initial operation, removal and repair have to be controlled resp. checked by an “authorized person” for explosion protection.
- 1.2 Take notice of the requirements of DIN EN 60079-14, DIN EN 60079-17 and DIN EN 1127-1, especially regarding the dust deposits and temperatures and follow the pertinent rules and regulations.
- 1.3 As soon as the device will be brought into the explosion hazardous area it has to be mounted immediately at the pre-caused place and a cable has to be brought into the cable gland.
- 1.4 Using the device in ambient temperatures $> +60\text{ °C}$, the applied connection cables have to be made for temperatures of min. $+80\text{ °C}$.
- 1.5 To secure the type of protection, the screw nut of the cable gland has to be fixed at the installation with a torsional force of min. 5.0 Nm.
ATTENTION! If it will be fastened too strong, the IP-protection can be affected.
- 1.6 Take notice of the specifications on the data plate.
- 1.7 The earth connection of the device has to be installed in such a way that mechanical damage will be excluded.
- 1.8 The level indicators may only be supplemented by such non-electrical components (Jib and measuring blade) which are in accordance with the demands of the directive 94/9/EC.
- 1.9 The maximum difference in pressure at the shaft passage must not exceed 80 mbar and the working temperature on the shaft seal must not exceed $+80\text{ °C}$, when installing level indicators in the silo wall under deviating atmospheric conditions.
- 1.10 In zone 0 or when flammable dust with a minimum ignition energy under 3 mJ or a minimum ignition temperature under $+300\text{ °C}$ (BAM assessment) are present, then the process connection, jib and measuring blade must be made of stainless steel.
- 1.11 If combustible gases and vapours of group IIC are present, sealing rings R0 and R2 must not be used.
- 1.12 The plastic measuring blade TK 150 must not be installed.
- 1.13 The **X** behind the EC-type-examination hint to special operation conditions:
The rotary blade level indicators DF with housing types A3 and A4 is approved for the use in hybrid mixtures.
Hybrid Mixtures according to the ATEX - directive hybrid mixtures are combustible dusts by simultaneous presence of combustible gases, vapours and fogs.

Installation in the interior of vessels or rooms in which combustible gases, vapours and fogs or hybrid mixtures are present.

Equipment category appropriation by zones.

Installation in vessels if inside zone 20 and zone 1 are present.

Order code **A3B2..D2** or **A4B2..D2**

Marking:

II 1D

II 2G



and **hybrid mixtures**

MOLLET Füllstandtechnik GmbH		Industriepark RIO 103 D-74706 Osterburken Tel. +49 62 91 64 400	CE 0044
Typ DF23 A4B2 C1 D2 G2AM2V			
Ex II 1D Ex II 2G	Ex ta III C T70°C	IBExU04ATEX1033 X	
	Ex db eb IIB T6	IP66	
-20°C ≤ Ta ≤ +45°C		Supply	220...240V~ AC
Δp -0,08bar...+0,08bar			50...60Hz 3,5VA
		Contact	1mA 4V...2A 240V~
Stück Nr.	1234567890	03/10	
Auftrag-Nr.	1234567890		

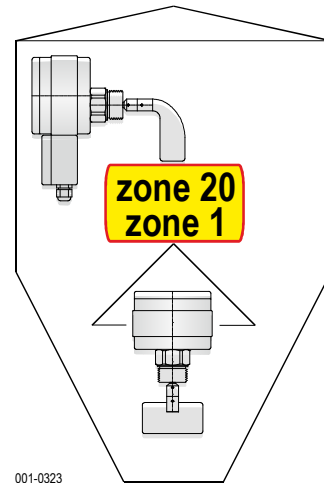

Ambient temperature Ta
maximum surface temperature T
Pressure, vacuum Δp, p (process)

see the back page



II 1D

II 2G

3. Additional special conditions and instructions for safe application regarding the models DF..A3B2 and DF..A4B2

- 3.1 It must be ensured that the measuring blade is always covered with material before the control head housing by selecting an appropriate installation position.
- 3.2 If the level indicator DF is completely installed within the zone 20 and combustible dust with a minimum ignition energy under 3 mJ or a minimum ignition temperature under +300 °C (BAM assessment) exists, then the control head housing must be made of stainless steel.
- 3.3 By means of an appropriate circuit it must be ensured that the level indicator is completely disconnected from the main power supply when the temperature cut-out responds and an automatic restart is prevented.

Ambient temperature T_a If the device is installed inside the vessel.

The ambient temperature T_a defines the maximum operating temperature of the indicators.
 Inside the vessel this is the air or the bulk goods temperature (Process temperature) nearby the device.

MOLLET Industriepark RIO 103 Füllstandtechnik GmbH D-74706 Osterburken Tel. +49 62 91 64 400		CE 0044
Typ DF23A4CB2C1D2G2AM2V		
II 1D Ex ta IIIC T70°C II 2G Ex db eb IIC T6		IExU04ATEX1033 X IP66
$-20^{\circ}\text{C} \leq T_a \leq +45^{\circ}\text{C}$ Δp -0,08bar...+0,08bar	Supply 220...240V~ AC 50...60Hz 3,5VA	
Stück Nr. 1234567890 03/10 Auftrag-Nr. 1234567890		Contact 1mA 4V...2A 240V~

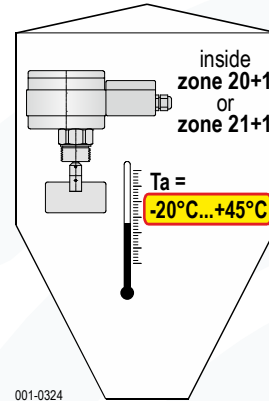

maximum surface temperature T If the device is installed inside the vessel.

The maximum surface temperature means the hottest point that can occur at the equipment in the case of a fault.

MOLLET Industriepark RIO 103 Füllstandtechnik GmbH D-74706 Osterburken Tel. +49 62 91 64 400		CE 0044
Typ DF23A4CB2C1D2G2AM2V		
II 1D Ex ta IIIC $T70^{\circ}\text{C}$ II 2G Ex db eb $T6$		IExU04ATEX1033 X IP66
$-20^{\circ}\text{C} \leq T_a \leq +45^{\circ}\text{C}$ Δp -0,08bar...+0,08bar	Supply 220...240V~ AC 50...60Hz 3,5VA	
Stück Nr. 1234567890 03/10 Auftrag-Nr. 1234567890		Contact 1mA 4V...2A 240V~

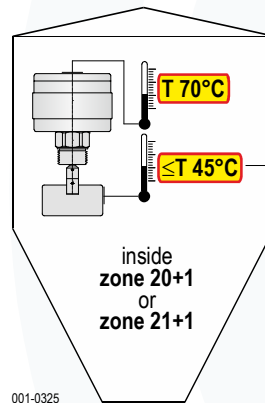

Remark:
 The surface temperature of the non-electrical part of the device (Jib and measuring blade) depends on the bulk goods temperature respectively the ambient temperature (Process temperature).
 The non-electrical parts produce no hot surface by itself.

Pressure, vacuum Δp , p (Process) If the device is installed inside the vessel.

MOLLET Industriepark RIO 103 Füllstandtechnik GmbH D-74706 Osterburken Tel. +49 62 91 64 400		CE 0044
Typ DF23A4CB2C1D2G2AM2V		
II 1D Ex ta IIIC T70°C II 2G Ex db eb IIC T6		IExU04ATEX1033 X IP66
$-20^{\circ}\text{C} \leq T_a \leq +45^{\circ}\text{C}$ Δp -0,08bar...+0,08bar	Supply 220...240V~ AC 50...60Hz 3,5VA	
Stück Nr. 1234567890 03/10 Auftrag-Nr. 1234567890		Contact 1mA 4V...2A 240V~

